



DURABLE • RELIABLE • VALUE



bisman®



★ DAKOTA

TABLE OF CONTENTS



01



Abrasives & Power Tool Accessories



Drill Bits & Power Tools

13



Fasteners

25



Hinges & Furniture Hardware

31



Gate Accessories & Locks

43



Hand Tools

57

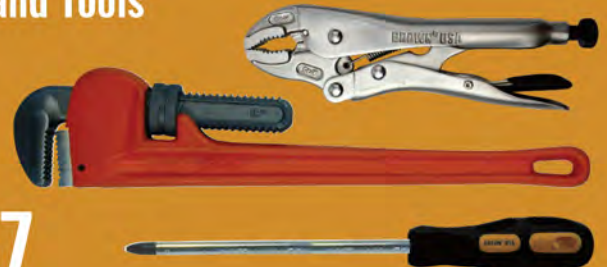

Masonry & Measuring

73



Agriculture & Pumps

85



Safety Equipment

105



bisman®

118



Plumbing Solutions

LINCOLN
PREMIUM PAINT TOOLS

158



DAKOTA

164



NEW PRODUCTS

NEW PR

Gate Accessories



Item Code	Size	Description
BRGHD2003	3"	Guide Wheel
BRGH5580W	55 x 80 mm	Roller Guide
BRGH00L	40 x 50 x 14 mm	L Bracket

Page
43



Measuring Tapes

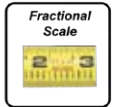

Item Code	Size	INN	CTN
NT16P	16' x 1"	6	60
NT25P	25' x 1"	6	48

Page
80



Self-Priming Pump + Pressure Tank System



DUAL
VOLTAGE

110 V

220 v

Item Code	HP	Frequency	Tank Capacity
BRWP100SET50-S	1	50 Hz	36 l / 9 gal

Page
99



Reflective Safety Vest



Item Code	Size	Color	INN	CTN
BRSV007RL	Large	Red	1	100

Page
111



PRODUCTS NEW PRODUCTS

Reciprocating Saw Blades



Item Code	Size	TPI	Width	Thickness	Ideal For
BRRB0606WD	6"	6	3/4"	1.25 mm	Wood Cutting
BRRB1205NWD	12"	5	1"	1.6 mm	Nail-Embedded Wood Cutting
BRRB0614MT	6"	14	1"	1.1 mm	Metal Cutting
BRRB6812GP	6"	8/12	1"	1.25 mm	General Purpose

Page
09



Welded Iron Wire Meshes



Item Code	Gauge	Opening	Pattern	Height	Length
BRMS1920	19	1"	Hexagonal	4'	150'
BRMS2210	22	1/2"	Hexagonal	3'	150'
BRMS2220	22	1/2"	Hexagonal	4'	150'

Page
99



Leather Work Boots



Item Code	Color	EUR SIZE	US SIZE
BRWB12YL	Wheat	45	12
BRWB11YL	Wheat	44	11
BRWB10BK	Black	43	10
BRWB09TB	Brown	42	9

Page
97



Sandpaper



Item Code	Size	Grits	Description
BRDP0080	9" x 11"	80	Coarse
BRDP0120	9" x 11"	120	Medium
BRDP0220	9" x 11"	220	Fine

Page
01



NEW PRODUCTS

NEW PR

Sanding Belts



Item Code	Size	Grits	Description
BRSB3080	3" x 21"	80	Coarse
BRSB4060	4" x 24"	60	Coarse



Page
01

Sponge Floats

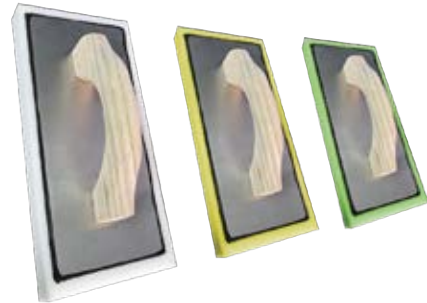

Item Code	Size	Material
BRSF01	1.0 mm	Aluminum
BRSF02	1.0 mm	Aluminum
BRSF03	1.0 mm	Aluminum



Page
74

Straight Tile Trim



Item Code	Size	Material
BRSTA10C	2,6 mm x 10 mm	Chrome



Page
77

Tile Cutter Wheels



Item Code	Size	INN	CTN
BRMTC0024WHL	7/8"	100	200
BRMTC0026WHL	7/8"	6	60



Page
75

PRODUCTS NEW PRODUCTS

Self-Drilling Cement Board Screws



Phillips Fat Head

Item Code	Size	Thread	Weight	CTN
BRDRS1L8114SP	1¼"	#8	1 lb	6 Boxes
BRDRS5L8158SP	1½"	#8	5 lbs	6 Boxes

Page
26



Hex Washer Head Self-Drill Screws



Hex Slot Head

Item Code	Size	Thread	Weight/Bag	QTY
BRHHS12100	1"	#12-14	1.2 lbs	100 PCS
BRHHS12150	1½"	#12-14	1.5 lbs	100 PCS
BRHHS12250B	2½"	#12-14	50 lbs	2,243 PCS
BRHHS12300B	3"	#12-14	50 lbs	1,952 PCS

Page
28



Cotton Line



Item Code	Length	Thickness	Weight	INN	CTN
BRNL3015	100 m	2 mm	0.4 lbs	5	30

Page
73



Metal Door Lock Cases



Item Code	Description	Hole Size	Width	Length	INN	CTN
BRMB001EP	Single	54 mm	89 mm	139 mm	6	60
BRMB002EP	Double	54 mm	137 mm	171 mm	6	30

Page
44



NEW PRODUCTS

NEW PR

Automatic Pump Control



Item Code	Voltage	Frequency	CTN
BRWP1400SH50	220	50 Hz	12

Page 103



Machetes

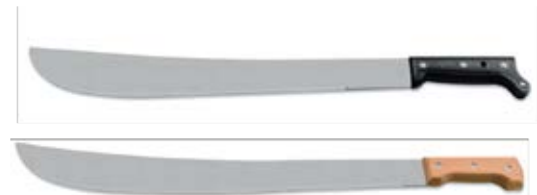

Item Code	Size	INN	CTN
BRAG2118	18"	6	36
BRAG2120	20"	6	36
BRAG2122	22"	6	36

Page 91



SDS-Plus Rotary Hammers



Item Code	Voltage	Power	Impact Force	Weight
PTH800P	120	6.6 AMP	3 J	8 lbs
PTH800P220	220	3.6 AMP	3 J	8 lbs

Page 24



Rotary Hammer Drills



Item Code	Voltage	Power	Frequency	Impact Energy
Z1C-DY34-28D	120	7.5 AMP	60 Hz	4 J
Z1C-DY34-220	220	4 AMP	50 Hz	4 J

Page 23



PRODUCTS NEW PRODUCTS

Door Locks



Item Code	Finish	INN	CTN
BRABCS02	Antique Brass	6	24
BRSSCS02	Stainless Steel	6	24



Page
49

Turbo Rim Diamond Blade



Arbor
1/8" - 5/8"

Item Code	Size	Max RPM	Diamond Rim	Cutting Method
9HS10TUGPW	9"	6,790	10 mm	Dry/Wet



Page
08

Stainless Steel Hinges



Item Code	Size	INN	CTN
DASS030	3" x 3" x 2 mm	5 Pairs	50 Pairs
DASS040	4" x 4" x 2.5 mm	5 Pairs	50 Pairs



Page
168

Diamond Blades



Arbor
1/8" - 5/8"

Item Code	Size	Max RPM	Diamond Rim	Cutting Method
DPCR0450	4 1/2"	13,300	7 mm	Wet
DPTR0450	4 1/2"	13,300	7 mm	Wet/Dry



Page
163

NEW PRODUCTS

NEW PR

Kitchen Faucet



Item Code	CTN
BMKF004CP	6

Page
126

bisman®

Lavatory Faucet



Item Code	Size	CTN
BMLF004SS	4"	12

Page
130

bisman®

Shower Faucet



Item Code	CTN
BMHSS7004	24

Page
146

bisman®

Bathroom Accessories

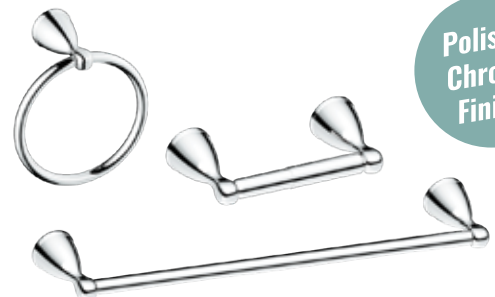

Polished
Chrome
Finish

Item Code	Description	CTN
BMBA004	Towel Bar	24
BMBA005	Towel Ring	24
BMBA006	Toilet Paper Holder	24

Page
130

bisman®

PRODUCTS NEW PRODUCTS

Square Floor Drains



Item Code	Size	CTN
BMFD44	4" x 4"	14
BMFD66	6" x 6"	10

bisman®

Page
122

White Pedestal Basin



A GRADE



Item Code	Size	CTN
D178A	22" x 18" x 33.5"	1

bisman®

Page
144

Wall Hung Basin



A GRADE



Item Code	Size	INN	CTN
BS2000A	19" x 17"	1	1

bisman®

Page
139

Wall Hung Urinal



Item Code	Size	CTN
E268W	16½" x 13¼" x 24"	1

bisman®

Page
143

GRINDING

Mini Grinding Set

Item Code	Description	Shank	INN	CTN
BRHGS0005	5 pcs	¼"	6	24
BRHGS0010	10 pcs	¼"	6	24

- Fits all electrical drills
- Various shapes included



Concrete Rubbing Brick

Item Code	Height	Width	Thickness	INN	CTN
BRRB006	6"	3"	1"	1	12



Made of silicon carbide

SANDING

Sanding Belts

Item Code	Size	Grits	Description	INN	CTN
BRSB3060	3" x 21"	60	Coarse	3	300
BRSB3080	3" x 21"	80	Coarse	3	300
BRSB4060	4" x 24"	60	Coarse	3	300
BRSB4080	4" x 24"	80	Coarse	3	300



- Aluminum oxide
- Backing: X-Wt
- Machine dependent
- Bond: phenolic resin



Sandpaper

Item Code	Size	Grits	Description	INN	CTN
BRDP0080	9" x 11"	80	Coarse	25	500
BRDP0120	9" x 11"	120	Medium	25	500
BRDP0220	9" x 11"	220	Fine	25	500



- Aluminum oxide
- Backing: C-Wt
- Bond: phenolic resin



Waterproof Abrasive Sandpaper

Item Code	Size	Grits	Description	INN	CTN
BRAP0060W	9" x 11"	60	Coarse	25	500
BRAP0080W	9" x 11"	80	Coarse	25	500
BRAP0120W	9" x 11"	120	Medium	25	500
BRAP0180W	9" x 11"	180	Medium	25	500
BRAP0240W	9" x 11"	240	Fine	25	500
BRAP0320W	9" x 11"	320	Fine	25	500
BRAP0400W	9" x 11"	400	Fine	25	500
BRAP1000W	9" x 11"	1000	Fine	25	500
BRAP1500W	9" x 11"	1500	Fine	25	500
BRAP2500W	9" x 11"	2500	Fine	25	500



- Aluminum oxide
- Backing: C-Wt
- Bond: phenolic resin



POWER TOOL ACCESSORIES

ABRASIVE DISCS

Metal Cutting Discs - T41

Item Code	Thickness	Diameter	Arbor	Max RPM	INN	CTN
BRMC2002	1/8"	14"	1"	4,300	5	25
BRMC2011	1/64"	14"	1"	3,900	5	25
BRMC2013	3/32"	14"	1"	4,300	5	25
BRMC2015GP	5/32"	14"	3/4"	8,500	10	20



Item Code	Thickness	Diameter	Arbor	Max RPM	INN	CTN
BRMC2003	1/8"	4 1/2"	1/8"	13,300	10	200



- Grain size: A 30



Metal Cutting Discs - T42

Item Code	Thickness	Diameter	Arbor	Max RPM	INN	CTN
BRMC2007	1/8"	4 1/2"	1/8"	13,300	10	200
BRMC2008	1/8"	7"	1/8"	8,500	10	100

- Grain size: A 30

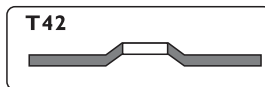

Super Thin Metal Cutting Discs - T41

Item Code	Thickness	Diameter	Arbor	Max RPM	INN	CTN
BRTMC3001	3/64"	4"	5/8"	15,200	25	500
BRTMC3002	3/64"	4 1/2"	7/8"	13,300	25	500
BRTMC3003	1/16"	7"	7/8"	8,500	25	200
BRTMC3008	5/64"	9"	7/8"	6,600	10	100



- Grain size: A 46



Super Thin Metal Cutting Discs - T42

Item Code	Thickness	Diameter	Arbor	Max RPM	INN	CTN
BRTMC3004	3/64"	4"	5/8"	15,200	25	500
BRTMC3005	3/64"	4 1/2"	7/8"	13,300	25	500
BRTMC3006	1/16"	7"	7/8"	8,500	10	100
BRTMC3007	5/64"	9"	7/8"	6,600	10	50

- Grain size: A 46
- Fast results in sheet metal and light gauge sections

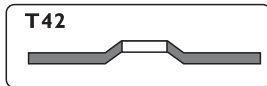

Metal Grinding Discs - T27

Item Code	Thickness	Diameter	Arbor	Max RPM	INN	CTN
BRMG1001	1/4"	4"	5/8"	15,200	5	100
BRMG1002	1/4"	4 1/2"	7/8"	13,300	5	100
BRMG1003	1/4"	7"	7/8"	8,500	5	50
BRMG1004	1/4"	9"	7/8"	6,600	5	50



- Grain size: A 24

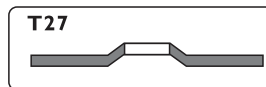

Metal Grinding Discs with Hub

Item Code	Thickness	Diameter	Arbor	Max RPM	INN	CTN
BRMG1005	1/4"	4 1/2"	5/8"	13,300	1	40
BRMG1006	1/4"	7"	5/8"	8,500	1	20



- Grain size: A 24

Stone Cutting Discs - T41

Item Code	Thickness	Diameter	Arbor	Max RPM	INN	CTN
BRSC4001	1/8"	4 1/2"	7/8"	13,300	10	200
BRSC4002	1/8"	7"	7/8"	8,500	10	100

- Grain size: C 30

T41

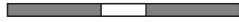

Recommended Tool



Zirconia Metal Grinding Flap Discs

Item Code	Grain Size	Diameter	Arbor	Max RPM	INN	CTN
BRFD5001	ZA 40	4 1/2"	7/8"	13,300	10	200
BRFD5002	ZA 60	4 1/2"	7/8"	13,300	10	200
BRFD5003	ZA 120	4 1/2"	7/8"	13,300	10	200
BRFD5004	ZA 80	4 1/2"	7/8"	13,300	10	200
BRFD70400	ZA 40	7"	7/8"	8,500	10	80
BRFD70600	ZA 60	7"	7/8"	8,500	10	80
BRFD70120	ZA 120	7"	7/8"	8,500	10	80
BRFD70800	ZA 80	7"	7/8"	8,500	10	80

- For cleaning metal surfaces
- Works on wood, fiberglass, and other surfaces
- Ideal for cleaning weld beads

Recommended Tool



Fiberglass layers provide more flexibility

CUP BRUSHES

Crimped Wire Cup Brushes

Item Code	Diameter	Axis	Wire Gauge	Thread Length	Max RPM	INN	CTN
95075	3"	5/8"	0.3 mm	23 mm	12,500	6	48
95100	4"	5/8"	0.3 mm	31 mm	8,500	6	24

- For cleaning metal, rust, slag, scale, and concrete waste
- For soft, light brushing

Recommended Tool



Made of carbon steel

Brass plated wires

Crimped Wire Cup Brushes with Shank

Item Code	Diameter	Shank	Wire Gauge	Thread Length	Max RPM	INN	CTN
99450BL	2"	1/4"	0.3 mm	16 mm	4,500	6	48
99475BL	3"	1/4"	0.3 mm	20 mm	4,500	6	48

- For cleaning metal, rust, slag, scale, and concrete waste
- For soft, light brushing

Recommended Tool



Made of carbon steel

Brass plated wires

Stainless Steel Crimped Wire Cup Brush

Item Code	Diameter	Axis	Wire Gauge	Thread Length	Max RPM	INN	CTN
BRWWB0004SS	4"	5/8"	0.3 mm	31 mm	8,500	4	24

- For cleaning metal, rust, slag, scale, and concrete waste
- For soft, light brushing



Made of carbon steel

Knotted Wire Cup Brushes

Item Code	Diameter	Axis	Wire Gauge	Braid Count	Thread Length	Max RPM	INN	CTN
997075	3"	5/8"	0.35 mm	18	20 mm	12,500	6	48
997100	4"	5/8"	0.35 mm	22	23 mm	8,500	6	36
997125	5"	5/8"	0.35 mm	26	25 mm	12,500	6	24

- For cleaning metal surfaces and weld beads
- For heavy duty brushing



Made of carbon steel

Single End Brush

Item Code	Diameter	Shank	Wire Gauge	Thread Length	Max RPM	INN	CTN
99025BL	1"	1/4"	0.3 mm	28 mm	4,500	12	48

- For cleaning metal, rust, slag, scale, and concrete waste
- For soft, light brushing



Made of carbon steel

Brass plated wires

Stainless Steel Knotted Wire Cup Brushes

Item Code	Diameter	Axis	Wire Gauge	Braid Count	Thread Length	Max RPM	INN	CTN
BRWWB0001SS	3"	5/8"	0.35 mm	18	20 mm	12,500	4	48
BRWWB0003SS	4"	5/8"	0.5 mm	22	23 mm	8,500	4	24

- For cleaning metal surfaces and weld beads
- For heavy duty brushing

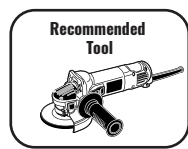

Made of carbon steel

WHEEL BRUSHES

Crimped Wheel Brush

Item Code	Diameter	Shank	Wire Gauge	Thread Length	Max RPM	INN	CTN
99275BL	3"	1/4"	0.3 mm	17 mm	4,500	6	36

- For cleaning and polishing rusted surfaces
- For soft, light brushing



Made of carbon steel

Brass plated wires

Knotted Wire Beveled Wheel Brush

Item Code	Diameter	Axis	Wire Gauge	Braid Count	Thread Length	Max RPM	INN	CTN
998400	4"	5/8"	0.35 mm	20	22 mm	12,500	4	24

- For cleaning weld beads
- For heavy duty brushing



Made of carbon steel

Knotted Wire Wheel Brush

Item Code	Diameter	Axis	Wire Gauge	Braid Count	Thread Length	Max RPM	INN	CTN
998100	4"	5/8"	0.5 mm	20	22 mm	20,000	4	24

- For cleaning weld beads
- For heavy duty brushing



Made of carbon steel

CARBON STEEL

**0.35 MM
WIRE GAUGE**

5/8" ARBOR

DIAMOND BLADES

DIAMOND BLADES

Continuous Rim



EXTRA-FINE CUTS
TILE
MARBLE

Segmented Rim

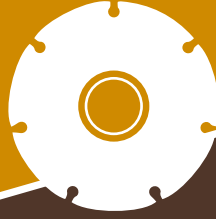

FAST CUTS
STONE
CONCRETE
BRICK

Turbo Rim



FAST AND SMOOTH CUTS
TILE
STONE
CONCRETE
MARBLE

Continuous Rim Diamond Blades

Item Code	Size	Arbor	Cutting Method	Diamond Rim	Max RPM	INN	CTN
4HS10TL80W	4"	7/8" - 5/8"	Wet	10 mm	14,000	10	100
45HS10TL80W	4 1/2"	7/8" - 5/8"	Wet	10 mm	13,200	10	100
7HS10TL80W	7"	7/8" - 5/8"	Wet	10 mm	8,000	10	40

- For durability and maximum cutting performance

Item Code	Size	Arbor	Cutting Method	Diamond Rim	Max RPM	INN	CTN
10HS10TL80W	10"	5/8"	Wet	10 mm	6,000	10	30

- For durability and maximum cutting performance

Recommended Tools

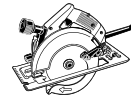

Segmented Rim Diamond Blades

Item Code	Size	Arbor	Cutting Method	Diamond Rim	Max RPM	INN	CTN
4HS10SGGPW	4"	7/8" - 5/8"	Dry	10 mm	14,000	10	100
45HS10SGGPW	4 1/2"	7/8" - 5/8"	Dry	10 mm	13,200	10	100
7HS10SGGPW	7"	7/8" - 5/8"	Dry	10 mm	8,000	10	40
14HS10SGGPW	14"	1"	Dry	10 mm	5,500	1	10

- For durability and maximum cutting performance
- Lasts longer than abrasive blades

Recommended Tools



Turbo Rim Diamond Blades

Item Code	Size	Arbor	Cutting Method	Diamond Rim	Max RPM	INN	CTN
4HS10TUGPW	4"	7/8" - 5/8"	Dry/Wet	10 mm	14,000	10	100
45HS10TUGPW	4 1/2"	7/8" - 5/8"	Dry/Wet	10 mm	13,200	10	100
5HS10TUGPW	5"	7/8" - 5/8"	Dry/Wet	10 mm	12,000	10	200
6HS10TUGPW	6"	7/8" - 5/8"	Dry/Wet	10 mm	10,185	10	100
7HS10TUGPW	7"	7/8" - 5/8"	Dry/Wet	10 mm	8,000	10	40
9HS10TUGPW	9"	7/8" - 5/8"	Dry/Wet	10 mm	6,790	10	100

- For durability and maximum cutting performance
- Lasts longer than abrasive blades
- Includes 1 blade and 1 adaptor

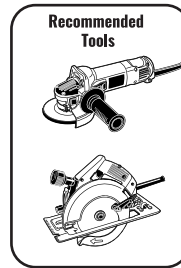

WOOD CUTTING

Straight Wood Cutting Jigsaw Blade

Item Code	Size	TPI	QTY	INN	CTN
BRJSB001	4"	9	5 PCS	25	400

- Cutting thickness: 3-30 mm

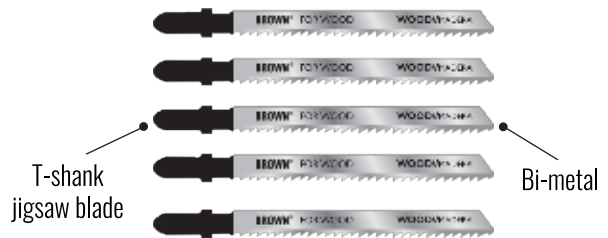

Straight Metal Cutting Jigsaw Blade

Item Code	Size	TPI	QTY	INN	CTN
BRJSB002	4"	18	5 PCS	25	400

- Cutting thickness: 2-6 mm



Reciprocating Saw Blades

Item Code	Size	TPI	Width	Thickness	Shank	Ideal For	INN	CTN
BRRB0606WD	6"	6	3/4"	1.25 mm	1/2"	Wood Cutting	12	240
BRRB0906WD	9"	6	3/4"	1.25 mm	1/2"	Wood Cutting	12	120

Item Code	Size	TPI	Width	Thickness	Shank	Ideal For	INN	CTN
BRRB1205NWD	12"	5	1"	1.6 mm	1/2"	Nail-Embedded Wood Cutting	12	240

Item Code	Size	TPI	Width	Thickness	Shank	Ideal For	INN	CTN
BRRB0614MT	6"	14	1"	1.1 mm	1/2"	Metal Cutting	12	240
BRRB0618MT	6"	18	1"	1.1 mm	1/2"	Metal Cutting	12	240
BRRB0914MT	9"	14	1"	1.1 mm	1/2"	Metal Cutting	12	120

Item Code	Size	TPI	Width	Thickness	Shank	Ideal For	INN	CTN
BRRB6812GP	6"	8/12	1"	1.25 mm	1/2"	General Purpose	12	240
BRRB9812GP	9"	8/12	1"	1.25 mm	1/2"	General Purpose	12	120

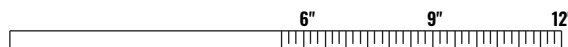

FOR WOOD CUTTING



FOR METAL CUTTING

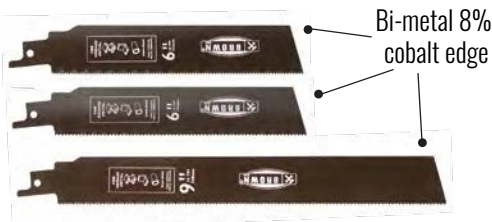

FOR GENERAL PURPOSE



Saw Blades For Wood

Item Code	Size	Teeth	Arbor	Max RPM	Application	INN	CTN
BRTC10400	10"	40	1"	6,000	Finishing	3	12
BRTC10600	10"	60	1"	6,000	Fine Cutting	3	12

- Manufactured for durability
- Maximum cutting performance
- Recommended for all types of woodwork
- Includes 5/8" and 7/8" adaptors

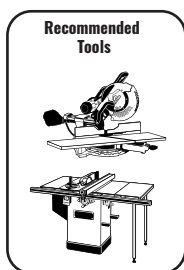

Construction grade carbide teeth

Expansion slots reduce noise and minimize vibrations

Saw Blades For Wood

Item Code	Size	Teeth	Arbor	Max RPM	Application	INN	CTN
BRTC12400	12"	40	1"	5,000	Finishing	3	12
BRTC12600	12"	60	1"	5,000	Fine Cutting	3	12

- Manufactured for durability
- Maximum cutting performance
- Recommended for all types of woodwork
- Includes 5/8" and 7/8" adaptors

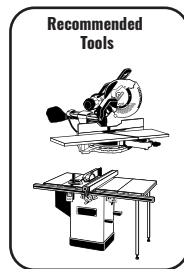

Construction grade carbide teeth

Expansion slots reduce noise and minimize vibrations



Saw Blades For Wood

Item Code	Size	Teeth	Arbor	Max RPM	Application	INN	CTN
BRTC282524	8 1/4"	24	5/8"	7,500	Framing	3	12
BRTC282540	8 1/4"	40	5/8"	7,500	Finishing	3	12

- High performance blade
- Superior durability
- Recommended for all types of woodwork



Construction grade carbide teeth



Thin kerf for fast and effortless cutting

STANDARD GRADE

Saw Blades For Wood

Item Code	Size	Teeth	Arbor	Max RPM	Application	INN	CTN
BRTC72518	7 1/4"	18	5/8"	8,300	Fast Cutting	6	48
BRTC72524	7 1/4"	24	5/8"	8,300	Framing	6	48
BRTC72540	7 1/4"	40	5/8"	8,300	Finishing	6	48

- High performance blade
- Superior durability
- Recommended for all types of woodwork



Construction grade carbide teeth



Thin kerf for fast and effortless cutting

STANDARD GRADE

Saw Blade For Wood

Item Code	Size	Teeth	Arbor	Max RPM	Application	INN	CTN
BRTC72525	7 1/4"	24	5/8"	8,300	Framing	10	50

- High performance blade
- Superior durability
- Recommended for all types of woodwork
- 10 pack



Construction grade carbide teeth



Thin kerf for fast and effortless cutting

STANDARD GRADE

Saw Blades For Wood

Item Code	Size	Teeth	Arbor	Max RPM	Application	INN	CTN
BRTC12040	12"	40	1"	5,000	Finishing	7	21
BRTC12060	12"	60	1"	5,000	Fine Cutting	7	21

- Recommended for smooth ripping and cross-cutting on all woods
- Includes 5/8" and 7/8" adaptors

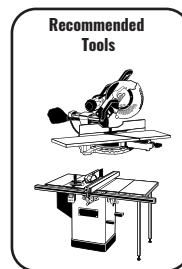

Anti-vibration design for smoother cuts

Ultra sharp edges for premium woodworking



Construction grade carbide teeth

CONSTRUCTION GRADE

Saw Blade For Wood

Item Code	Size	Teeth	Arbor	Max RPM	Application	INN	CTN
BRTC14072	14"	72	1"	4,300	Extra Fine Cutting	3	9

- Recommended for smooth ripping and cross-cutting on all woods
- Includes $\frac{5}{8}$ " and $\frac{7}{8}$ " adaptors

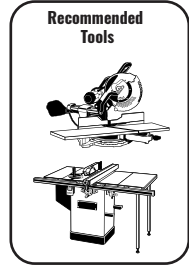

Ultra sharp edges for premium woodworking

CONSTRUCTION GRADE



Anti-vibration design for smoother cuts

Construction grade carbide teeth

Saw Blades For Wood

Item Code	Size	Teeth	Arbor	Max RPM	Application	INN	CTN
BRTC450240	4 1/2"	24	7/8" - 5/8"	12,000	Framing	10	100
BRTC450340	4 1/2"	40	7/8" - 5/8"	12,000	Finishing	10	100

- Recommended for smooth ripping and cross-cutting on all woods

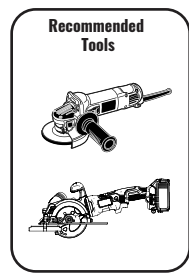

CONSTRUCTION GRADE



Thin kerf for fast and effortless cutting

Construction grade carbide teeth

Saw Blades For Wood

Item Code	Size	Teeth	Arbor	Max RPM	Application	INN	CTN
BRTC61024	10"	24	1"	6,000	Framing	3	24
BRTC61040	10"	40	1"	6,000	Finishing	3	24
BRTC61060	10"	60	1"	6,000	Fine Cutting	3	24
BRTC61080	10"	80	1"	6,000	Extra Fine Cutting	3	24

- Recommended for smooth ripping and cross-cutting on all woods
- Includes $\frac{5}{8}$ " and $\frac{7}{8}$ " adaptors

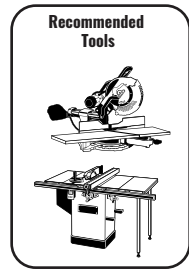

Anti-vibration design for smoother cuts

CONSTRUCTION GRADE



Thin kerf for fast and effortless cutting

Construction grade carbide teeth

Saw Blades For Wood

CONSTRUCTION
GRADE

Item Code	Size	Teeth	Arbor	Max RPM	Application	INN	CTN
BRTC93118	7 1/4"	18	5/8"	8,300	Fast Cutting	6	48
BRTC93124	7 1/4"	24	5/8"	8,300	Framing	6	48
BRTC93140	7 1/4"	40	5/8"	8,300	Finishing	6	48



Thin kerf for fast and effortless cutting

Construction grade carbide teeth

- Recommended for smooth ripping and cross-cutting on all woods

DRILL BITS

Carbide Tip Masonry Drill Bits

Item Code	Size	INN	CTN
BR1208	1/8" x 3"	24	480
BR1212	3/16" x 4"	24	480
BR1216	T-1/4" x 6"	24	480
BR1217	1/4" x 6"	24	360
BR1220	5/16" x 4"	24	360
BR1221	5/16" x 6"	24	360
BR1224	3/8" x 4"	24	360
BR1225	3/8" x 6"	24	240
BR1232	1/2" x 6"	24	240
BR1240	T-5/8" x 6"	24	240
BR1316	1/4" x 12"	12	72
BR1320	5/16" x 12"	12	72
BR1324	3/8" x 12"	12	72
BR1332	1/2" x 12"	12	72
BR1340	5/8" x 12"	12	72
BR1348	3/4" x 12"	12	72

Item Code	Size	Bag	INN	CTN
BR1208B	1/8" x 3"	10 PCS	24	480
BR1212B	3/16" x 4"	10 PCS	24	480
BR1216B	T-1/4" x 6"	10 PCS	24	480
BR1217B	1/4" x 6"	10 PCS	24	360
BR1220B	5/16" x 4"	10 PCS	24	360
BR1221B	5/16" x 6"	10 PCS	24	360
BR1224B	3/8" x 4"	5 PCS	24	360
BR1225B	3/8" x 6"	5 PCS	24	240
BR1232B	1/2" x 6"	4 PCS	24	240
BR1240B	T-5/8" x 6"	4 PCS	24	240



Hardened premium carbide bit stays sharp longer for easier drilling

Manufactured using premium carbon steel



Black Oxide High Speed Drill Bits

Item Code	Size	Shank	Bag	INN	CTN
BR104	1/16" x 1 1/8"	-	2 PCS	24	480
BR106	3/32" x 2 1/4"	-	2 PCS	24	480
BR108	1/8" x 2 3/4"	-	2 PCS	24	480
BR110	5/32" x 3 1/8"	-	2 PCS	24	480
BR112	3/16" x 3 1/2"	-	2 PCS	24	480
BR116	1/4" x 4"	-	-	24	480
BR120	5/16" x 4 1/2"	-	-	24	240
BR124	3/8" x 5"	-	-	24	240
BR128	1/16" x 5 1/2"	3/8"	-	24	240
BR132	1/2" x 6"	3/8"	-	24	240



Black oxide finish for superior durability

Manufactured using premium M2 high speed steel

Heat treated to be measurably harder



POWER TOOL ACCESSORIES

Concrete Screw Drill Bits

Item Code	Size	INN	CTN
BR1349	5/32" x 5 1/2"	24	360
BR1350	T-3/16" x 5 1/2"	24	360
BR1351	5/32" x 4 1/2"	24	360

Item Code	Size	Bag	INN	CTN
BR1349B	5/32" x 5 1/2"	10 PCS	15	60
BR1350B	T-3/16" x 5 1/2"	10 PCS	15	60
BR1351B	5/32" x 4 1/2"	10 PCS	15	60

- Carbide tip

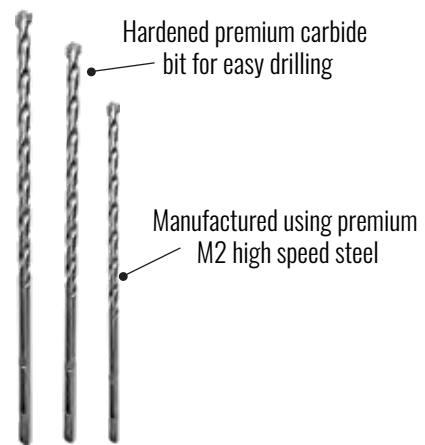
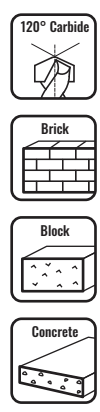

SDS Concrete Drill Bits

Item Code	Size	INN	CTN
BR31201	5/32" x 6"	12	192
BR31202	3/16" x 6"	12	192
BR31203	1/4" x 4"	12	192
BR31204	1/4" x 6"	12	192
BR31205	5/16" x 6"	12	192
BR31206	5/16" x 10"	6	192
BR31207	3/8" x 6"	12	192

Item Code	Size	INN	CTN
BR31208	3/8" x 12"	6	24
BR31209	1/2" x 6"	6	192
BR31210	1/2" x 12"	6	24
BR31211	9/16" x 6"	6	192
BR31212	9/16" x 10"	6	24
BR31213	5/8" x 6"	6	192
BR31214	5/8" x 12"	6	24

- Tougher and able to handle extreme loads

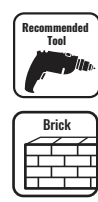

Titanium High Speed Drill Bits

Item Code	Size	INN	CTN
BR204	1/16" x 1 1/8"	24	480
BR206	3/32" x 2 1/4"	24	480
BR208	1/8" x 2 3/4"	24	480
BR209	9/64" x 2 1/8"	24	480
BR210	5/32" x 3 1/8"	24	480
BR211	11/64" x 3 1/4"	24	480
BR212	3/16" x 3 1/2"	24	480
BR214	1/32" x 3 3/4"	24	480
BR216	1/4" x 4"	24	480
BR220	5/16" x 4 1/2"	24	240
BR224	3/8" x 5"	24	240
BR232	1/2" x 6"	24	144

Item Code	Size	Bag	INN	CTN
BR204B	1/16" x 1 1/8"	10 PCS	6	300
BR206B	3/32" x 2 1/4"	10 PCS	6	240
BR208B	1/8" x 2 3/4"	10 PCS	6	180
BR209B	9/64" x 2 1/8"	10 PCS	6	180
BR210B	5/32" x 3 1/8"	10 PCS	6	180
BR211B	11/64" x 3 1/4"	10 PCS	6	120
BR212B	3/16" x 3 1/2"	10 PCS	6	120
BR214B	1/32" x 3 3/4"	10 PCS	6	600
BR216B	1/4" x 4"	10 PCS	6	60
BR220B	5/16" x 4 1/2"	5 PCS	5	40
BR224B	3/8" x 5"	5 PCS	5	30
BR232B	1/2" x 6"	5 PCS	5	20

- Lasts up to six times longer than regular HSS drill bits



Flat Wood Drill Bits

Item Code	Size	Shank	Head	INN	CTN
FWB001	1"	1/4"	Hex	20	200
FWB0012	1/2"	1/4"	Hex	20	200
FWB0014	1/4"	1/4"	Hex	20	200
FWB0034	3/4"	1/4"	Hex	20	200
FWB0038	3/8"	1/4"	Hex	20	200
FWB0058	5/8"	1/4"	Hex	20	200
FWB0078	7/8"	1/4"	Hex	20	200

Item Code	Size	Shank	Head	INN	CTN
FWB0112	1 1/2"	1/4"	Hex	20	200
FWB0114	1 1/4"	1/4"	Hex	20	200
FWB0118	1 1/8"	1/4"	Hex	20	200
FWB0138	1 3/8"	1/4"	Hex	20	200
FWB0516	5/16"	1/4"	Hex	20	200
FWB0716	7/16"	1/4"	Hex	20	200
FWB0916	9/16"	1/4"	Hex	20	200



C65 high carbon steel for greater strength and hardness

Angled edges for clean and fast cuts



Pilot Bits

Item Code	Size	INN	CTN
BR28110	1/4" x 3"	12	240
BR28114	1/4" x 3 3/4"	12	240

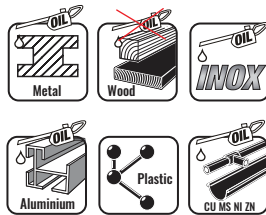

- Includes pilot bit with 1 flat



Forstner Bit

Item Code	Size	Diameter	Round Shank	INN	CTN
BR56122	1 3/8" x 5 1/2"	1 3/8"	3/8"	10	50



- Boring bit with screw
- Drill presses for hard and soft woods
- Long lasting performance

Precision balanced center point

2 precision ground cutting edges



Glass Drill Bits

Item Code	Size	INN	CTN
BRGDB0014	1/4"	12	480
BRGDB0018	1/8"	12	480
BRGDB00316	3/16"	24	480
BRGDB0038	3/8"	24	480



- Drills clean accurate holes in ceramic tiles, glass, and mirrors



Spearhead tungsten carbide tip drill bit

2-Flute Straight Bits

Item Code	Shank	D	H	INN	CTN
LC01020404	1/4"	1/4"	25/32"	10	200
LC01020408	1/2"	1/4"	25/32"	10	200
LC01020608	1/2"	3/8"	13/16"	10	200
LC01020804	1/4"	1/2"	13/16"	10	200
LC01020808	1/2"	1/2"	13/16"	10	200

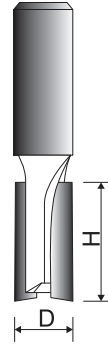
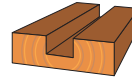

Mortising Bit

Item Code	Shank	D	H	INN	CTN
LC01040804	1/4"	1/2"	1/2"	10	200

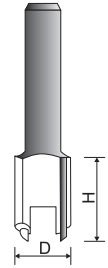
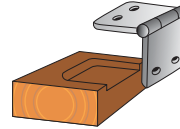

Hinge Boring Bit

Item Code	Shank	D	H	INN	CTN
LC01090608	3/8"	1 3/8"	39/64"	10	200

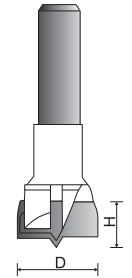
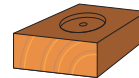

Flush Trim Bits

Item Code	Shank	D	H	INN	CTN
LC01141438	1/4"	3/8"	1 3/16"	10	200
LC02010804	1/4"	1/2"	1 3/16"	10	200



With ball bearings

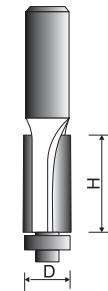

Z3 Flush Trim Bit

Item Code	Shank	D	H	INN	CTN
LC02070804	1/4"	1/2"	1 3/16"	10	200



With ball bearings

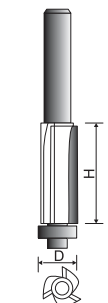

Corner Round Bits

Item Code	Shank	D	R	H	B	INN	CTN
LC06020808	1/2"	1"	1/4"	1/16"	1/4"	20	200
LC06021208	1/2"	1 1/4"	3/8"	5/8"	3/8"	10	200

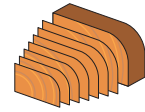

With ball bearings

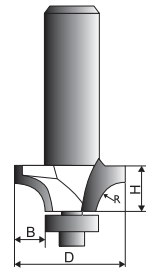

Roman Ogee Bit

Item Code	Shank	D	R	H	B	INN	CTN
LC08013208	1/2"	2 1/2"	1/2"	1 1/4"	1"	6	120

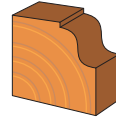

With ball bearings

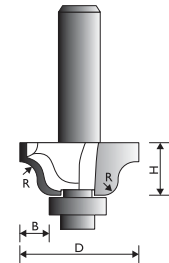

Double Roman Ogee Bit

Item Code	Shank	D	R	H	B	INN	CTN
LC08051604	1/4"	1 3/8"	1/4"	1 1/16"	1/2"	10	200

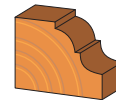

With ball bearings

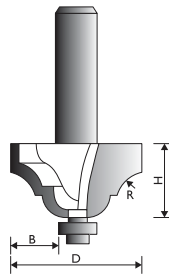

Classical Ogee Bits

Item Code	Shank	D	R1	R2	H	B	INN	CTN
LC08081604	1/4"	1 1/2"	3/16"	5/16"	5/8"	-	10	200
LC08081608	1/2"	1 1/2"	3/16"	5/16"	5/8"	1/2"	10	200

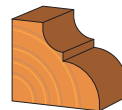

With ball bearings

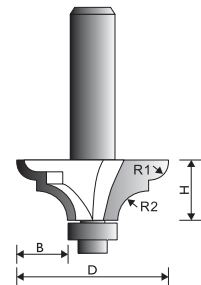

Multi-Beading Bits

Item Code	Shank	D	R	H	INN	CTN
LC09021604	1/4"	1/8"	1/8"	1"	10	200
LC09021608	1/2"	1/8"	1/8"	1"	10	200

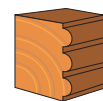

With ball bearings

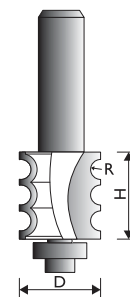

Handrail Classical Bit

Item Code	Shank	D	R1	R2	H	B	INN	CTN
LC12041208	1/2"	1 7/8"	3/32"	1/32"	3/4"	3/4"	6	120

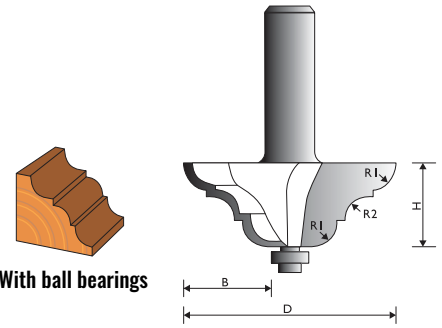

With ball bearings

Raised Panel Bits

Item Code	Shank	D	R	H	B	INN	CTN
LC12061204	1/4"	2"	5/8"	1 9/32"	3/4"	4	80
LC12062408	1/2"	3 1/2"	1 3/8"	5/8"	1 1/2"	4	80

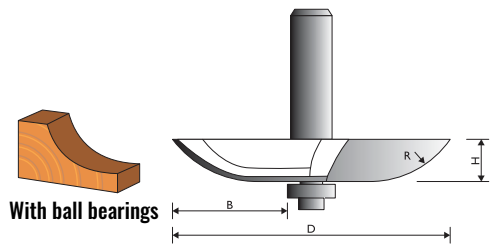

With ball bearings

Item Code	Shank	D	H	A	B	INN	CTN
LC12072408B	1/2"	3 1/2"	3/4"	25°	1 1/2"	4	80

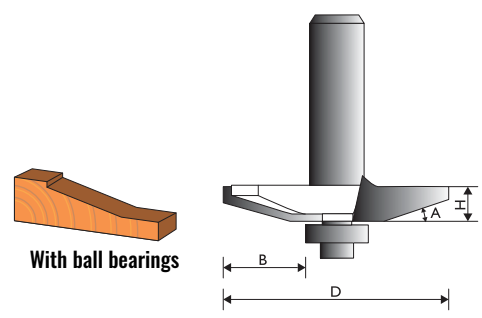

With ball bearings

Item Code	Shank	D	R	H	B	INN	CTN
LC12081708	1/2"	2 5/8"	1 1/16"	5/8"	1 11/16"	4	80

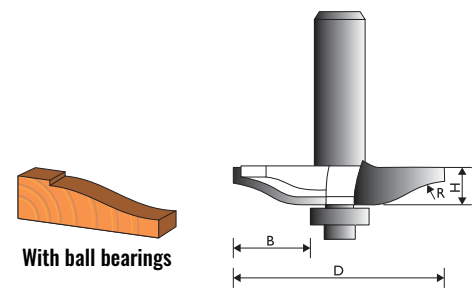

With ball bearings

Ogee Raised Panel Bit

Item Code	Shank	D	H	B	INN	CTN
LC12122408	1/2"	2 1/2"	7/8"	1 5/16"	6	120

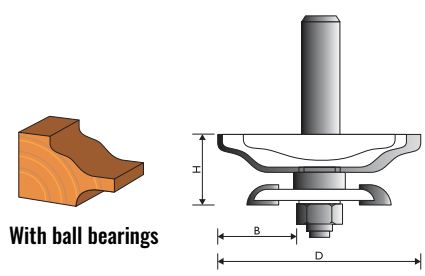

With ball bearings

- With back cutter

Key Hole Bit

Item Code	Shank	D	D1	H	B	INN	CTN
LC16020604M	1/4"	3/8"	1/4"	3/8"	3/16"	10	200



Ogee Reversible Stile & Rail Bit

Item Code	Shank	D	H	B	INN	CTN
LC17223504	1/2"	1 1/32"	1/8"	3 3/64"	6	120

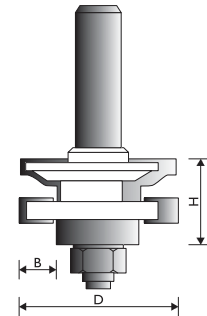
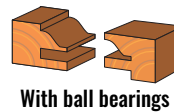

Plug Cutters

Item Code	Size	INN	CTN
WHS0012	1/2"	12	144
WHS0038	3/8"	12	144

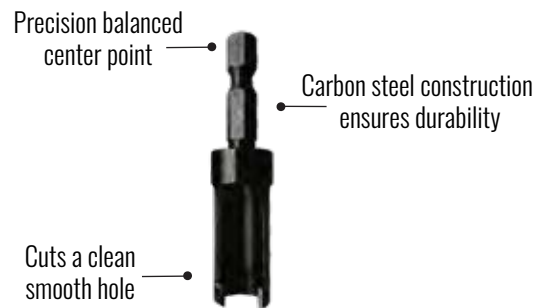

Keyless Drill Chuck

Item Code	Size	INN	CTN
BRDCK0012	1/2"	5	50



Chuck Keys

Item Code	Size	INN	CTN
BRDCK013	1/2"	20	100
BRDCK039	3/8"	20	100

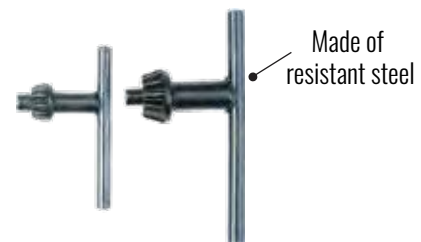

- Fits all standard 1/2" drills and hammer drills



Drill Chuck with Keys

Item Code	Size	INN	CTN
BRHCD0012	1/2"	5	40
BRHCD0038	3/8"	10	50



- High precision threaded and tapered
- For forward and reversing drills

Jaws hardened for resistance



INSTALLATION

Door Lock Installation Kit

Item Code	Material	PCS	INN	CTN
HSAW006	Bi-Metal	4	6	48

- Includes 1" and 2 1/8" bi-metal hole saws, mandrel, adapter, and guide
- Suitable for wood and metal doors
- Guide included for quickly and easily centering drilling locations
- 1500 RPM max



3 PCS Lock Installation Kit

Item Code	INN	CTN
HSAW003	6	72

- Includes:
- 1" flat wood bit
- 2 1/8" hole saw
- Hole saw mandrel

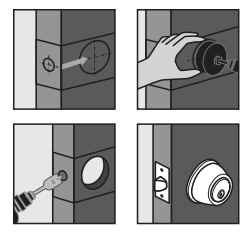

Lock Installation Kit

Item Code	Material	PCS	INN	CTN
HSAW004	Bi-Metal	3	6	48

- Includes:
- 2 1/8" bi-metal saw
- 1" bi-metal saw
- 1/4" pilot drill bit
- For installing 2 1/8" lock sets and deadbolts with 1" attached holes

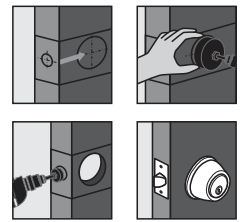

Bi-Metal Hole Saws

Item Code	Size	INN	CTN
BR28014	⅝"	6	72
BR28016	1"	6	72
BR28018	⅞"	6	72
BR28020	1¼"	6	72
BR28022	1⅜"	6	72
BR28024	1½"	6	72
BR28028	1¾"	6	72
BR28032	2"	6	72
BR28034	2⅛"	6	72
BR28040	2½"	6	36
BR28048	3"	6	36
BR28056	3½"	6	24
BR28064	4"	6	24

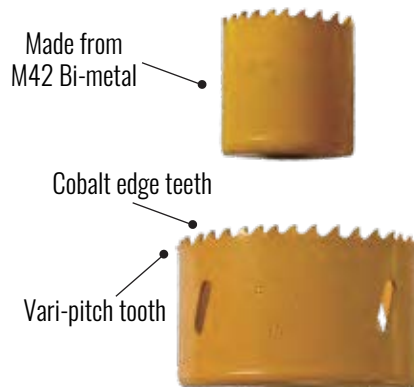

- Smooth fast cuts

ARBORS

Arbor For Bi-Metal Hole Saws

Item Code	Shank	INN	CTN
BR28100	⅞"	6	72



- Pilot drill size: ¼" x 3"
- Metal hole saw size: ⅝" to 1⅞"
- Thread: ½" - 20



2-Pin Arbor

Item Code	Shank	INN	CTN
BR28102	⅞"	6	72



- Pilot drill size: ¼" x 3"
- Metal hole saw size: 1¼" to 6"
- Thread: ⅝" - 18



Arbor Adaptor

Item Code	Hole Saw	INN	CTN
BR28112	1¼" - 6"	12	240

- Internal thread: ½" - 20
- External thread: ⅝" - 18



POWER BITS

Double-Ended Impact Rated Bit

Item Code	Length	Thread Size	INN	CTN
BRB45276BL	1 1/16"	#2	10	500

- Heat-treated to 60-64 HRC



Phillips



Slotted



Made of S2 steel

1/4" Impact Rated Nut Setters

Item Code	Size	Shank	INN	CTN
BRB45060BL	1/4" x 1 1/8"	1/4"	10	400
BRB45062BL	5/16" x 1 1/8"	1/4"	10	400
BRB45064BL	3/8" x 1 1/8"	1/4"	10	400

Item Code	Size	Shank	Bag	INN	CTN
BRB45060HC	1/4" x 1 1/8"	1/4"	5 PCS	10	100
BRB45062HC	5/16" x 1 1/8"	1/4"	5 PCS	10	100
BRB45064HC	3/8" x 1 1/8"	1/4"	5 PCS	10	100



Hex



Made of industrial grade chrome vanadium steel

Magnetic tip

5 PCS Impact Rated Insert Bit Set

Item Code	Size	PCS	INN	CTN
BRB3500BL	2"	5	6	120

- Heat-treated to 60-64 HRC



1 Slotted



4 Phillips

Magnetic tip



Made of S2 steel

5 PCS Impact Rated Insert Bit Set

Item Code	Size	PCS	INN	CTN
BRB3502BL	2"	5	6	120

- Heat-treated to 60-64 HRC



5 Phillips

Magnetic tip



Made of S2 steel

Impact Rated Phillips Power Bits

Item Code	Length	Thread Size	INN	CTN
BRB45002BL	1"	#2	10	500

Item Code	Length	Thread Size	PCS	INN	CTN
BRB45002HC	1"	#2	5	15	180

- Heat-treated to 60-64 HRC



Phillips

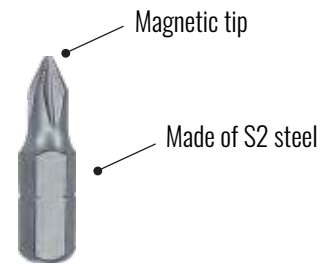

Impact Rated Phillips Power Bits

Item Code	Length	Thread Size	INN	CTN
BRB45010BL	2"	#2	10	500
BRB45012BL	2"	#3	10	500

Item Code	Length	Thread Size	PCS	INN	CTN
BRB45010HC	2"	#2	5	15	180
BRB45012HC	2"	#3	5	15	180

- Heat-treated to 60-64 HRC



Phillips

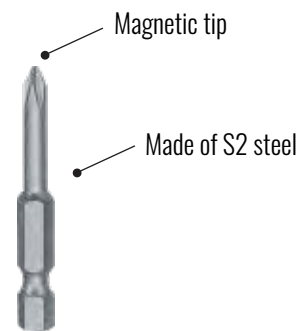

Impact Rated Square Insert Bit

Item Code	Length	Thread Size	INN	CTN
BRB45182BL	2"	#1	10	500



Slotted

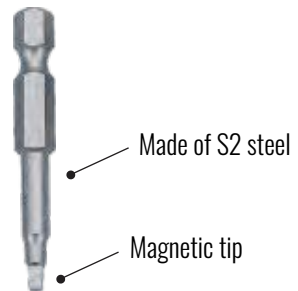

Impact Rated Drywall Screw Setter

Item Code	Length	Thread Size	INN	CTN
BRB45058BL	1"	#2	10	500

Item Code	Length	Thread Size	PCS	INN	CTN
BRB45058HC	1"	#2	5	15	180

- Heat-treated to 60-64 HRC



Phillips



ANGLE GRINDERS

Angle Grinders

Item Code	Size	Voltage	Power	Frequency	Cable Cord	CTN
0102	4 1/2"	110	7 AMPS	60 Hz	2 m UL	8
0104	4 1/2"	220	4 AMPS	50 Hz	2 m VED	8

- Input power: 820W
- No load speed: 12,000 r/min
- Accessories: 1 side handle and 1 spanner
- Rotable handle for convenient use

Item Code	Description	INN	CTN
0102B	Replacement brush for 0102	10	500



Grinding disc diameter: 115 mm

HAMMER DRILLS

Rotary Hammer Drills

Item Code	Voltage	Power	Frequency	Impact Energy	Certification	CTN
Z1C-DY34-28D	120	7.5 AMPS	60 Hz	4 J	ETL/CE	3
Z1C-DY34-220	220	4 AMPS	50 Hz	4 J	GS/EMC/CE	3

- Ideal for drilling and chipping through concrete and masonry
- Impact rate: 4000 IPM
- Capacity: 1 9/16" (wood), 1/32" (concrete), 5/8" (steel)
- No load speed: 750 RPM
- Includes:
 - 3 PCS - 6" SDS masonry drill bits
 - 2 PCS - 9" and 12" chisels (flat and needle)
 - Storage case

Item Code	Description	CTN
Z1C-CB11	Carbon Brush	3
Z1C-CB22	Carbon Brush	3



Auxiliary side handle for better grip and control

SDS-Plus Rotary Hammers

Item Code	Voltage	Power	Impact Force	Weight	CTN
PTH800P	120	6.6 AMPS	3 J	8 lbs	4
PTH800P220	220	3.6 AMPS	3 J	8 lbs	4



Auxiliary side handle for better grip and control

- Input power: 800W
- No load speed: 1100 r/min
- Includes:
 - 1 PC - 10" x 3/8" point chisel bit
 - 1 PC - 10" x 3/8" flat chisel bit
 - 3 PCS - 6" SDS plus masonry bits: 3/25", 2/5", 12/25"
 - Auxiliary handle
 - Carrying case

SUPER THIN METAL CUTTING DISC

METAL GRINDING DISC

SDS CONCRETE DRILL BIT



POWER TOOLS

SCREWS



FASTENERS

TYPES OF SCREWS

Drywall Screws



Colors available: Black and grey
Type of coating: Grey phosphate (48h sst)
Head types: #2 Phillips drive and pan head
Point type: Sharp point
Thread type: Fine and coarse
Made in Taiwan

Roofing Screws



Colors available: Silver
Type of coating: Anti-corrosion (100h sst)
Head type: Hex head
Point types: Reduced #1 drill point, fast engineered drill point, and sharp point
Thread type: Fine and coarse
Made in Taiwan

Concrete Tapping Screws



Colors available: Blue and white
Type of coating: Blue and white ruspert
Head type: #2 Phillips drive and hex head
Point types: Sharp point
Thread type: Fine and coarse
Made in Taiwan

Cement Board Screws



Colors available: Green
Type of coating: Anti-corrosion (100h sst)
Head type: Wafer head
Point types: Sharp and drill point
Thread type: Coarse
Made in Taiwan

Self-Drilling Cement Board Screws

Item Code	Size	Thread	Weight	CTN
BRDRS1L8114	1 1/4"	#8	1 lb	6 Boxes
BRDRS1L8158	1 5/8"	#8	1 lb	6 Boxes
BRDRS5L8114	1 1/4"	#8	5 lbs	6 Boxes
BRDRS5L8158	1 5/8"	#8	5 lbs	6 Boxes



Phillips Flat Head



- Drill point
- Large wafer head with ribs
- 1000 hours of salt spray testing on the green ceramic coating
- Ideal for attaching cement board to wood and light-gauge steel
- Made in Taiwan

Self-Drilling Cement Board Screws

Item Code	Size	Thread	Weight	CTN
BRDRS1L8114SP	1 1/4"	#8	1 lb	6 Boxes
BRDRS1L8158SP	1 5/8"	#8	1 lb	6 Boxes
BRDRS5L8114SP	1 1/4"	#8	5 lbs	6 Boxes
BRDRS5L8158SP	1 5/8"	#8	5 lbs	6 Boxes

- Sharp point
- Large wafer head with ribs
- 1000 hours of salt spray testing on green ceramic coating
- Ideal for attaching cement board to wood and light-gauge steel
- Made in Taiwan



Phillips Flat Head



Coarse Thread Drywall Screws

Item Code	Size	Thread	Weight	CTN
BRDWC1L6034	3/4"	#6	1 lb	6 Boxes
BRDWC1L6100	1"	#6	1 lb	6 Boxes
BRDWC1L6112	1 1/2"	#6	1 lb	6 Boxes
BRDWC1L6114	1 1/4"	#6	1 lb	6 Boxes
BRDWC1L6118	1 1/8"	#6	1 lb	6 Boxes
BRDWC1L6200	2"	#6	1 lb	6 Boxes
BRDWC1L6158	1 5/8"	#6	1 lb	6 Boxes
BRDWC1L6212	2 1/2"	#6	1 lb	6 Boxes
BRDWC1L8112	1 1/2"	#8	1 lb	6 Boxes
BRDWC1L8200	2"	#8	1 lb	6 Boxes
BRDWC1L8212	2 1/2"	#8	1 lb	6 Boxes
BRDWC1L8300	3"	#8	1 lb	6 Boxes
BRDWC5L6034	3/4"	#6	5 lbs	6 Boxes

Item Code	Size	Thread	Weight	CTN
BRDWC5L6100	1"	#6	5 lbs	6 Boxes
BRDWC5L6112	1 1/2"	#6	5 lbs	6 Boxes
BRDWC5L6114	1 1/4"	#6	5 lbs	6 Boxes
BRDWC5L6158	1 5/8"	#6	5 lbs	6 Boxes
BRDWC5L6212	2 1/2"	#6	5 lbs	6 Boxes
BRDWC5L8200	2"	#8	5 lbs	6 Boxes
BRDWC5L8300	3"	#8	5 lbs	6 Boxes



Phillips Flat Head



- 48 hour phosphate coated
- Sharp point for faster penetration and better holding power
- Best for attaching gypsum board to light-gauge steel studs
- Interior use only
- Made in Taiwan

Coarse Thread Drywall Screws in Bulk

Item Code	Size	Thread	Weight/CTN	QTY
BRDWC6034B	3/4"	#6	47 lbs	20,000 PCS
BRDWC6100B	1"	#6	30 lbs	10,000 PCS
BRDWC6112B	1 1/2"	#6	27.5 lbs	8,000 PCS
BRDWC6114B	1 1/4"	#6	25 lbs	6,000 PCS
BRDWC6158B	1 5/8"	#6	22 lbs	5,000 PCS
BRDWC6212B	2 1/2"	#6	19 lbs	3,000 PCS
BRDWC8200B	2"	#8	21.5 lbs	3,000 PCS
BRDWC8300B	3"	#8	20 lbs	2,000 PCS



Phillips Flat Head



Fine Thread Drywall Screws

Item Code	Size	Thread	Weight	Box	CTN
BRDWF1L6112	1 1/2"	#6	1 lb	239 PCS	6 Boxes
BRDWF1L6114	1 1/4"	#6	1 lb	270 PCS	6 Boxes
BRDWF5L6112	1 1/2"	#6	5 lbs	1,194 PCS	6 Boxes
BRDWF5L6114	1 1/4"	#6	5 lbs	1,350 PCS	6 Boxes

- 48 hour phosphate coated
- Sharp point for faster penetration and better holding power
- Best for attaching gypsum board to light-gauge steel studs
- Interior use only
- Made in Taiwan



Phillips Flat Head



Fine Thread Drywall Screws in Bulk

Item Code	Size	Thread	Weight/CTN	QTY
BRDWF6112B	1 1/2"	#6	24.5 lbs	6,000 PCS
BRDWF6114B	1 1/4"	#6	28 lbs	8,000 PCS
BRDWF6118B	1 1/8"	#6	33 lbs	10,000 PCS
BRDWF716B	7/16"	#7	19 lbs	15,000 PCS



Phillips Flat Head



Stitch Screws

Item Code	Size	Thread	Weight/Bag	QTY	CTN
BRHHS12034	3/4"	#12-14	1 lbs	100 PCS	20 BAGS
BRHHS12078	7/8"	#12-14	1.2 lbs	100 PCS	20 BAGS

- Rubber bonded washer (OD14), C1022 hardened
- Silver ruspert coating
- 1000 hours of salt spray test
- Made in Taiwan



Hex Slot Head



Stitch Screws in Bulk

Item Code	Size	Thread	Weight/CTN	QTY
BRHHS12034B	3/4"	#12-14	50 lbs	4,735 PCS
BRHHS12078B	7/8"	#12-14	50 lbs	4,124 PCS



Hex Washer Head Self-Drill Screws

Item Code	Size	Thread	Weight/Bag	QTY	CTN
BRHHS12100	1"	#12-14	1.2 lbs	100 PCS	20 BAGS
BRHHS12150	1½"	#12-14	1.5 lbs	100 PCS	15 BAGS
BRHHS12200	2"	#12-14	1.8 lbs	100 PCS	12 BAGS
BRHHS12250	2½"	#12-14	2.2 lbs	100 PCS	10 BAGS
BRHHS12300	3"	#12-14	2.5 lbs	100 PCS	9 BAGS



Hex Slot Head



- Rubber bonded washer (OD14), C1022 hardened
- Silver ruspert coating
- 1000 hours of salt spray test
- Made in Taiwan

Hex Washer Head Self-Drill Screws in Bulk

Item Code	Size	Thread	Weight/CTN	QTY
BRHHS12100B	1"	#12-14	50 lbs	4,057 PCS
BRHHS12150B	1½"	#12-14	50 lbs	3,277 PCS
BRHHS12200B	2"	#12-14	50 lbs	2,687 PCS
BRHHS12250B	2½"	#12-14	50 lbs	2,243 PCS
BRHHS12300B	3"	#12-14	50 lbs	1,952 PCS



Hex Slot Head



Hex Washer Head Self-Drill Screws

Item Code	Size	Thread	Weight/Bag	QTY	CTN
BRHHS12200	2"	#12-14	9 lbs	100 PCS	48 BAGS
BRHHS12250	2½"	#12-14	10 lbs	100 PCS	48 BAGS
BRHHS12300	3"	#12-14	12 lbs	100 PCS	48 BAGS



Concrete Nails

Item Code	Size	Bag	CTN
BRCN30100	1" x 3.0 mm	100 PCS	120 Boxes
BRCN30150	1½" x 3.0 mm	100 PCS	100 Boxes
BRCN36200	2" x 3.6 mm	100 PCS	60 Boxes
BRCN36250	2½" x 3.6 mm	100 PCS	45 Boxes
BRCN42300	3" x 4.2 mm	100 PCS	20 Boxes



Concrete Tapping Screws

Item Code	Size	Box	INN	CTN
BRTC3001	3/16" x 1 1/4"	100 PCS	6 Boxes	24 Boxes
BRTC3002	3/16" x 1 3/4"	100 PCS	6 Boxes	24 Boxes
BRTC3003	3/16" x 2 1/4"	100 PCS	6 Boxes	24 Boxes
BRTC3004	3/16" x 2 3/4"	100 PCS	6 Boxes	24 Boxes
BRTC3008	3/16" x 3 1/4"	100 PCS	6 Boxes	24 Boxes
BRTC0001	1/4" x 1/4"	100 PCS	6 Boxes	24 Boxes
BRTC0002	1/4" x 1 3/4"	100 PCS	6 Boxes	24 Boxes
BRTC0003	1/4" x 2 1/4"	100 PCS	6 Boxes	24 Boxes
BRTC0004	1/4" x 2 3/4"	100 PCS	6 Boxes	24 Boxes
BRTC0012	1/4" x 3 1/4"	100 PCS	6 Boxes	24 Boxes
BRTC0013	1/4" x 3 3/4"	100 PCS	-	6 Boxes
BRTC0014	1/4" x 4"	100 PCS	-	6 Boxes
BRTC0015	1/4" x 5"	100 PCS	-	6 Boxes

- Reversible and removable
- For fastening in concrete, brick, and block
- Diamond tip allows for superior penetrating into hard materials
- Made in Taiwan



Hex Slot Head



With 1 piece carbide tip
concrete screw drill bit



No anchors
required

Concrete Tapping Screws

Item Code	Size	Box	INN	CTN
BRTC3005	3/16" x 1 3/4"	100 PCS	6 Boxes	24 Boxes
BRTC3006	3/16" x 2 1/4"	100 PCS	6 Boxes	24 Boxes
BRTC3007	3/16" x 2 3/4"	100 PCS	6 Boxes	24 Boxes
BRTC3008	3/16" x 3 1/4"	100 PCS	6 Boxes	24 Boxes
BRTC3010	3/16" x 4"	100 PCS	6 Boxes	24 Boxes
BRTC3011	3/16" x 1 1/4"	100 PCS	6 Boxes	24 Boxes
BRTC0011	1/4" x 1 1/4"	100 PCS	6 Boxes	24 Boxes
BRTC0005	1/4" x 1 3/4"	100 PCS	6 Boxes	24 Boxes
BRTC0006	1/4" x 2 1/4"	100 PCS	6 Boxes	24 Boxes
BRTC0007	1/4" x 2 3/4"	100 PCS	6 Boxes	24 Boxes
BRTC0008	1/4" x 3 1/4"	100 PCS	6 Boxes	24 Boxes
BRTC0009	1/4" x 3 3/4"	100 PCS	6 Boxes	24 Boxes
BRTC0010	1/4" x 4"	100 PCS	-	6 Boxes

- Reversible and removable
- For fastening in concrete, brick, and block
- Made in Taiwan



Phillips Flat Head



With 1 piece carbide tip
concrete screw drill bit



No anchors
required

Concrete Tapping Screws

Item Code	Size	Box	INN	CTN
BRWTC310	3/16" x 1 1/4"	100 PCS	6 Boxes	24 Boxes
BRWTC320	3/16" x 1 3/4"	100 PCS	6 Boxes	24 Boxes
BRWTC330	3/16" x 2 1/4"	100 PCS	6 Boxes	24 Boxes
BRWTC340	3/16" x 2 3/4"	100 PCS	6 Boxes	24 Boxes
BRWTC375	3/16" x 3 1/4"	100 PCS	6 Boxes	24 Boxes
BRWTC002	1/4" x 1 3/4"	100 PCS	6 Boxes	24 Boxes
BRWTC003	1/4" x 2 1/4"	100 PCS	6 Boxes	24 Boxes
BRWTC004	1/4" x 2 3/4"	100 PCS	6 Boxes	24 Boxes
BRWTC012	1/4" x 3 1/4"	100 PCS	6 Boxes	24 Boxes
BRWTC013	1/4" x 3 3/4"	100 PCS	-	6 Boxes

- Reversible and removable
- For fastening in concrete, brick, and block
- Diamond tip allows for superior penetrating into hard materials
- Made in Taiwan

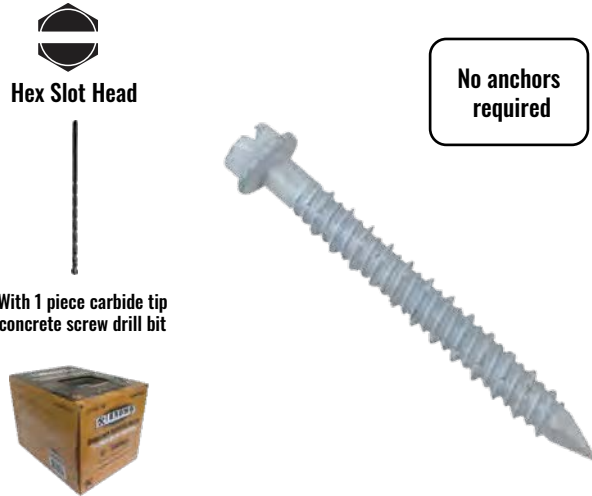

Concrete Tapping Screws

Item Code	Size	Box	INN	CTN
BRWTC390	3/16" x 1 1/4"	100 PCS	6 Boxes	24 Boxes
BRWTC350	3/16" x 1 3/4"	100 PCS	6 Boxes	24 Boxes
BRWTC360	3/16" x 2 1/4"	100 PCS	6 Boxes	24 Boxes
BRWTC370	3/16" x 2 3/4"	100 PCS	6 Boxes	24 Boxes
BRWTC375	3/16" x 3 1/4"	100 PCS	6 Boxes	24 Boxes
BRWTC380	3/16" x 4"	100 PCS	6 Boxes	24 Boxes
BRWTC011	1/4" x 1 1/4"	100 PCS	6 Boxes	24 Boxes
BRWTC005	1/4" x 1 3/4"	100 PCS	6 Boxes	24 Boxes
BRWTC006	1/4" x 2 1/4"	100 PCS	6 Boxes	24 Boxes
BRWTC007	1/4" x 2 3/4"	100 PCS	6 Boxes	24 Boxes
BRWTC008	1/4" x 3 1/4"	100 PCS	6 Boxes	24 Boxes
BRWTC009	1/4" x 3 3/4"	100 PCS	6 Boxes	24 Boxes
BRWTC010	1/4" x 4"	100 PCS	-	6 Boxes

- Reversible and removable
- For fastening in concrete, brick, and block
- Made in Taiwan

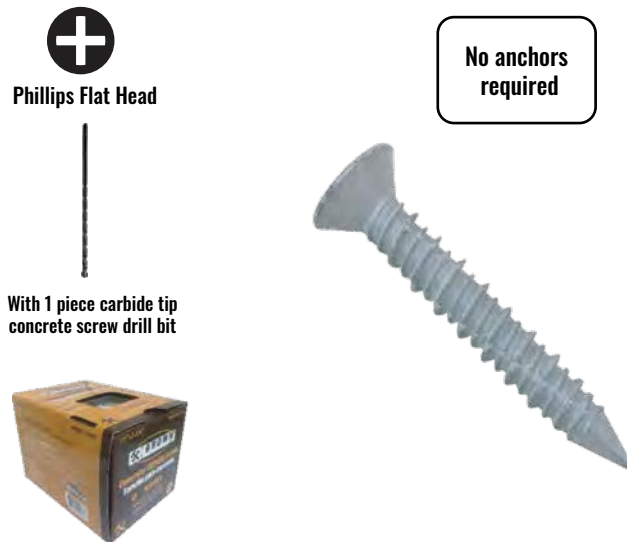

BED HINGES

Bed Hinge

Item Code	Size	QTY	CTN
BH4435	5"	4 Pairs/Set	100 Sets



CABINET HINGES

Cabinet Hinges

Item Code	Finish	Description	INN	CTN
BR56444	Satin Nickel	Spring Type Flat	10 Pairs	200 Pairs
BR56445	Aluminum	Spring Type Flat	10 Pairs	200 Pairs
BR56446	White	Spring Type Flat	10 Pairs	200 Pairs
BR56447	Copper Plated	Spring Type Flat	10 Pairs	200 Pairs
BR56448	Antique Bronze	Spring Type Flat	10 Pairs	200 Pairs
BR56449	Antique Copper	Spring Type Flat	10 Pairs	200 Pairs
BR56450	Polished Bronze	Spring Type Flat	10 Pairs	200 Pairs



- Includes screws
- Heavy duty

Item Code	Finish	Description	INN	CTN
BR56451	Copper Plated	Spring Type Step	10 Pairs	200 Pairs
BR56452	Antique Bronze	Spring Type Step	10 Pairs	200 Pairs
BR56453	Antique Copper	Spring Type Step	10 Pairs	200 Pairs
BR56454	Polished Bronze	Spring Type Step	10 Pairs	200 Pairs

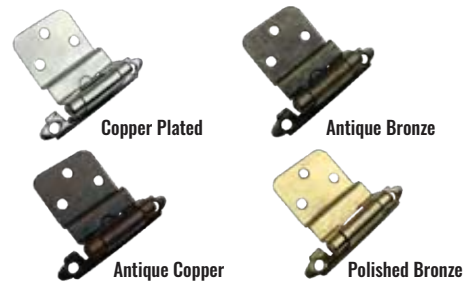

- Includes screws
- Heavy duty

CONCEALED HINGES

Cabinet Door Hinges

Item Code	Size	Hinge Type	INN	CTN
BRCH001	3 3/8"	Full Overlay	50 Pairs	100 Pairs

- Includes screws

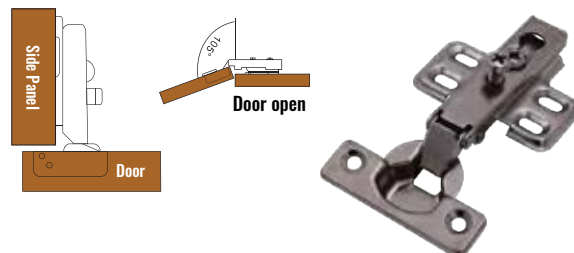

Cabinet Door Hinges

Item Code	Size	Hinge Type	INN	CTN
BRCH002	3"	Half Overlay	50 Pairs	100 Sets

- Includes screws

Item Code	Size	Hinge Type	INN	CTN
BRCH002SC	3"	Full and Half Overlay	50 Pairs	100 Pairs

- Includes screws
- Short arm

Item Code	Size	Hinge Type	INN	CTN
BRCH005	4"	Full Overlay	50 Pairs	100 Pairs

- Includes screws

Item Code	Size	Hinge Type	INN	CTN
BRCH006	4"	Full Overlay	50 Pairs	100 Pairs

- Includes screws
- Two way clip-on

Item Code	Size	Hinge Type	INN	CTN
BRCH007SC	4.5"	Full Overlay	50 Pairs	100 Pairs

- Includes screws

Item Code	Size	Hinge Type	INN	CTN
BRCH004	4"	Insert	50 Pairs	100 Pairs

- Includes screws

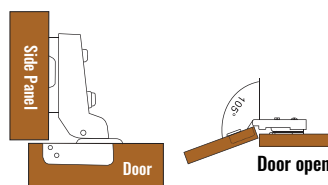
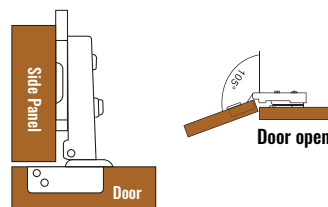
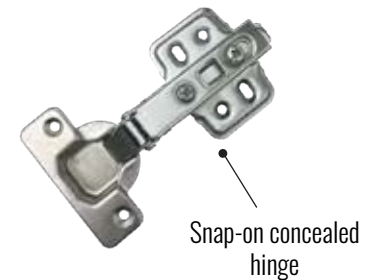
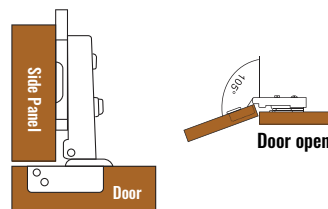
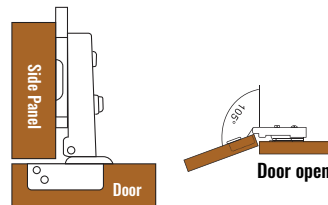
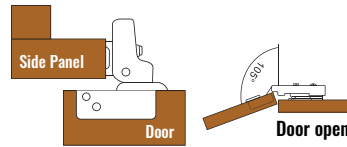
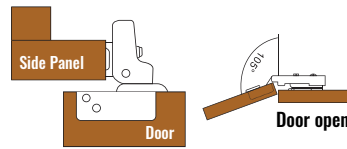

DOOR HINGES

Solid Brass Hinges

Item Code	Size	INN	CTN
SBH0030	3" x 3" x 2.4 mm	6 Pairs	48 Pairs
SBH0035	3.5" x 3.5" x 2.6 mm	6 Pairs	36 Pairs
SBH0040	4" x 4" x 2.8 mm	6 Pairs	36 Pairs

- Made of 100% solid brass
- Rust resistant
- Provides smooth operation
- For high frequency doors
- Thicker and of much higher quality than residential hinges
- Screws included



Ball bearings included

Architectural Grade

Stainless Steel Hinges

Item Code	Size	INN	CTN
22500	2.5" x 2.5" x 2 mm	6 Pairs	60 Pairs
23000	3" x 3" x 2 mm	6 Pairs	48 Pairs
23500	3.5" x 3.5" x 2.5 mm	6 Pairs	36 Pairs
24000	4" x 4" x 3 mm	6 Pairs	36 Pairs

- Ball bearings not included
- For high frequency doors
- Thicker and of much higher quality than residential hinges
- Stainless steel screws included



Architectural Grade

Item Code	Size	INN	CTN
BRSS3000	3" x 3" x 2 mm	6 Pairs	48 Pairs
BRSS3500	3.5" x 3.5" x 2.5 mm	6 Pairs	36 Pairs
BRSS4000	4" x 4" x 3 mm	6 Pairs	36 Pairs

- Ball bearings and 2 security studs included
- Provides smooth operation
- For high frequency doors
- Thicker and of much higher quality than residential hinges
- Stainless steel screws included



Architectural Grade

Item Code	Size	INN	CTN
SSH2500	2.5" x 2.5" x 2 mm	6 Pairs	60 Pairs
SSH3000	3" x 3" x 2 mm	6 Pairs	48 Pairs
SSH3500	3.5" x 3.5" x 2.5 mm	6 Pairs	36 Pairs
SSH4000	4" x 4" x 3 mm	6 Pairs	36 Pairs
SSH4300	4" x 3" x 3 mm	6 Pairs	36 Pairs

- Ball bearings included
- Provides smooth operation
- For high frequency doors
- Thicker and of much higher quality than residential hinges
- Stainless steel screws included



Architectural Grade

Solid Steel Hinges

Item Code	Size	Finish	INN	CTN
BR4325BP	4" x 3" x 2.5 mm	Brass Plated	12 Pairs	48 Pairs
BR4325CP	4" x 3" x 2.5 mm	Chrome Plated	12 Pairs	48 Pairs
BR4325SN	4" x 3" x 2.5 mm	Satin Nickel	12 Pairs	48 Pairs

Architectural Grade



- Ball bearings included
- Made of solid steel
- Provides smooth operation
- For high frequency doors
- Thicker and of much higher quality than residential hinges
- Screws included

Item Code	Size	Finish	CTN
BRH0025BP	2.5" x 2.5" x 2 mm	Brass Plated	50 Pairs
BRH0030BP	3" x 3" x 2 mm	Brass Plated	50 Pairs
BRH0035BP	3.5" x 3.5" x 2.2 mm	Brass Plated	50 Pairs
BRH0040BP	4" x 4" x 2.2 mm	Brass Plated	50 Pairs

Architectural Grade



- Ball bearings not included
- Made of solid steel
- For high frequency doors
- Thicker and of much higher quality than residential hinges
- Screws included

Item Code	Size	Finish	CTN
BRH0025SN	2.5" x 2.5" x 2 mm	Satin Nickel Plated	50 Pairs
BRH0030SN	3" x 3" x 2 mm	Satin Nickel Plated	50 Pairs
BRH0035SN	3.5" x 3.5" x 2.2 mm	Satin Nickel Plated	50 Pairs
BRH0040SN	4" x 4" x 2.2 mm	Satin Nickel Plated	50 Pairs
BRH0035NBB	3.5" x 3.5" x 2.2 mm	Satin Nickel Plated	50 Pairs

Architectural Grade

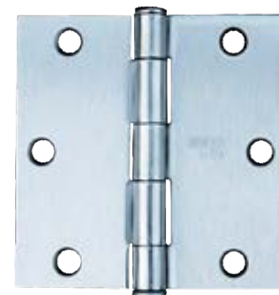

- Ball bearings not included
- Made of solid steel
- For high frequency doors
- Thicker and of much higher quality than residential hinges
- Screws included



HINGES



DOUBLE ACTION HINGES

Double Action Hinges

Item Code	Size	Finish	INN	CTN
BRDAH003	3"	Black Japanned	1 Pair	25 Pairs
BRDAH004	4"	Black Japanned	1 Pair	25 Pairs

- Screws included



CABINET ROLLER CATCH

Cabinet Roller Catches

Item Code	Finish	INN	CTN
RC4000	Zinc Plated	100	1000
RC5000	Antique Copper	100	1000



Magnetic Cabinet Catch

Item Code	Size	INN	CTN
RC6000	Small	100	1000



DRAWER SLIDES

Ball Bearing Drawer Slides

Item Code	Size	Bearing Balls	CTN
BRMDS012	12"	26	15
BRMDS014	14"	32	15
BRMDS016	16"	36	15
BRMDS018	18"	42	15
BRMDS020	20"	46	15
BRMDS022	22"	60	15



- Three sections
- Metal thickness: 0.9 mm - 0.9mm - 1.0 mm
- Width: 42 mm
- Includes 10 screws
- Load capacity: 25 kgs

Ball Bearing Drawer Slides

Item Code	Size	Bearing Balls	CTN
BRSCDS1400	14"	48	15
BRSCDS1600	16"	72	15
BRSCDS1800	18"	84	15
BRSCDS2000	20"	84	15
BRSCDS2200	22"	96	15



- Self closing with three sections
- Metal thickness: 1.2 mm - 1.2mm - 1.5 mm
- Width: 45 mm
- Includes 12 screws
- Load capacity: 35 kgs

White Drawer Slides

Item Code	Size	CTN	Item Code	Size	CTN
DS1200	12"	20	DS1800	18"	20
DS1400	14"	20	DS2000	20"	20
DS1600	16"	20	DS2200	22"	20

- Includes 12 screws
- Metal thickness: 0.9 mm
- Load capacity: 10 kgs



DOOR STOP

Door Wedges

Item Code	Color	QTY	INN	CTN
BRRDS001	Black	2 PCS	6	60
BRRDS002	White	2 PCS	6	60



Door Stop Floor Mounts

Item Code	Size	Finish	Packaging	INN	CTN
BR8185ABBL	1¾" x 1"	Antique Brass	Double Blister	12	120
BR8185SS	1¾" x 1"	Stainless Steel	Box	25	250
BR8185SSBL	1¾" x 1"	Stainless Steel	Double Blister	12	120

- Prevents doors from damaging walls
- Rubber bumpers soften the impact



DOOR HANDLES

Diecast Door Handles

Item Code	Size	Finish	INN	CTN
TRO04	12"	Copper Plated	10	40
TRO05	12"	Antique Bronze	10	40
TRO06	12"	Antique Copper	10	40
TRO07	12"	Polished Bronze	10	40
TRO08	12"	Satin Nickel	10	40

- Architectural design



Diecast Door Handles

Item Code	Size	Finish	INN	CTN
TR009	8.5"	Antique Bronze	10	40
TR010	8.5"	Antique Copper	10	40
TR011	8.5"	Polished Brass	10	40
TR012	8.5"	Satin Nickel	10	40

- Architectural design



PULL HANDLES & KNOBS

Cabinet Handles

Item Code	Size	Finish	Center to Center	INN	CTN
BR008796AB	4½"	Antique Brass	3½"	50	500
BR008796AC	4½"	Antique Copper	3½"	50	600

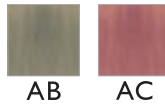

- Made in Colombia



Item Code	Size	Finish	Center to Center	INN	CTN
BR013096AB	4½"	Antique Brass	3"	50	400
BR013096AC	4½"	Antique Copper	3"	50	400

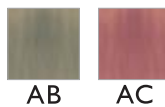

- Made in Colombia



Item Code	Size	Finish	Center to Center	INN	CTN
BR015996AB	4½"	Antique Brass	3"	50	400
BR015996AC	4½"	Antique Copper	3"	50	800

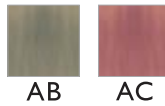

- Made in Colombia



Item Code	Size	Finish	Center to Center	INN	CTN
BR0175AB	4½"	Antique Brass	3¾"	50	500
BR0175AC	4½"	Antique Copper	3¾"	50	450

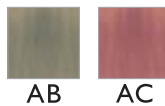

- Made in Colombia



Item Code	Size	Finish	Center to Center	INN	CTN
BR012996AB	4½"	Antique Brass	3½"	50	400



- Made in Colombia



Item Code	Size	Finish	Center to Center	INN	CTN
BR008796SN	4½"	Satin Nickel	3¾"	50	450



- Made in Colombia



Cabinet Handles

Item Code	Size	Finish	Center to Center	INN	CTN
BR006196SN	4½"	Satin Nickel	3¾"	50	600

- Made in Colombia



SN



Item Code	Size	Finish	Center to Center	INN	CTN
BR013996	4½"	Satin Nickel	3¾"	50	450

- Made in Colombia



SN



Item Code	Size	Finish	Center to Center	INN	CTN
BR014096SN	4½"	Satin Nickel	3¾"	50	400

- Made in Colombia



SN



Item Code	Size	Finish	Center to Center	INN	CTN
BR014196	4½"	Satin Nickel	3¾"	50	450

- Made in Colombia



SN



Item Code	Size	Finish	Center to Center	INN	CTN
BR017096	4½"	Satin Nickel	3¾"	50	400

- Made in Colombia



SN



Item Code	Size	Finish	Center to Center	INN	CTN
BR017196	4½"	Satin Nickel	3¾"	50	300

- Made in Colombia



SN



Item Code	Size	Finish	Center to Center	INN	CTN
BR025696SN	4½"	Satin Nickel	3¾"	50	450

- Made in Colombia



SN



Cabinet Handles

Item Code	Size	Finish	Center to Center	INN	CTN
BR017296SN	4½"	Satin Nickel	3¾"	50	500



Item Code	Size	Finish	Center to Center	INN	CTN
BR0155128SNA	5½"	Satin Nickel	5"	35	210



Item Code	Size	Finish	Center to Center	INN	CTN
BR0158128SNA	5½"	Satin Nickel	5"	20	120



Item Code	Size	Finish	Center to Center	INN	CTN
BR0158150SNA	6"	Satin Nickel	3¾"	25	125
BR0158300SNA	12"	Satin Nickel	9½"	20	120



Item Code	Size	Finish	Center to Center	INN	CTN
BR018796	4½"	Satin Nickel	3¾"	30	300
BR0187128	5½"	Satin Nickel	5"	30	240



Aluminum Cabinet Handles

Item Code	Size	Finish	Center to Center	INN	CTN
BR024696SNA	4½"	Aluminium	3¾"	30	270

- Made in Colombia

Item Code	Size	Finish	Center to Center	INN	CTN
BR0246128SNA	5¾"	Aluminium	5"	25	225

- Made in Colombia



Cabinet Knobs

Item Code	Finish	Diameter	Height	INN	CTN
BR0088AB	Antique Brass	38 mm	1/2"	100	1000
BR0088AC	Antique Copper	38 mm	1/2"	100	800

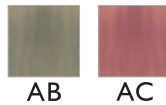

Item Code	Finish	Diameter	Height	INN	CTN
BR0089AB	Antique Brass	30 mm	1/8"	100	700
BR0089AC	Antique Copper	30 mm	1/8"	100	800

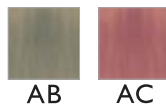

Item Code	Finish	Diameter	Height	INN	CTN
BR0092AB35	Antique Brass	34 mm	1/2"	100	800
BR0092AC35	Antique Copper	34 mm	1/2"	100	1200

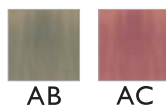

Item Code	Finish	Diameter	Height	INN	CTN
BR0145AB35	Antique Brass	38 mm	1"	100	600



Item Code	Finish	Diameter	Height	INN	CTN
BR0146AB	Antique Brass	38 mm	1/8"	100	500
BR0146AC	Antique Copper	38 mm	1/8"	100	1000

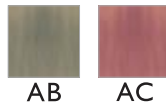

Item Code	Finish	Diameter	Height	INN	CTN
BR0165	Satin Nickel	25 mm	1/8"	50	500



Cabinet Knobs

Item Code	Finish	Diameter	Height	INN	CTN
BR0222AB	Antique Brass	35 mm	¼"	100	900
BR0222AC	Antique Copper	35 mm	¼"	100	900
BR0222SN	Satin Nickel	35 mm	¼"	100	900

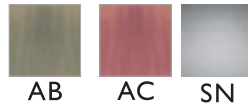

- Made in Colombia

Item Code	Finish	Diameter	Height	INN	CTN
BR0227	Satin Nickel	36 mm	1"	50	450



Item Code	Finish	Diameter	Height	INN	CTN
BR0229	Satin Nickel	32 mm	1"	50	500



Item Code	Finish	Diameter	Height	INN	CTN
BR0230	Satin Nickel	34 mm	⅞"	50	500



WALL BRACKETS

Wall Brackets

Item Code	Size	Color	Metal Thickness	INN	CTN
BRWB0068	6" x 8"	White	1.0 mm	12	120 Pairs
BRWB0068G	6" x 8"	Grey	1.0 mm	12	72 Pairs
BRWB0810	8" x 10"	White	1.0 mm	12	72 Pairs
BRWB0810G	8" x 10"	Grey	1.0 mm	12	72 Pairs
BRWB1012	10" x 12"	White	1.0 mm	12	60 Pairs
BRWB1012G	10" x 12"	Grey	1.0 mm	12	60 Pairs
BRWB1214	12" x 14"	White	1.0 mm	12	60 Pairs
BRWB1214G	12" x 14"	Grey	1.0 mm	12	60 Pairs

- Made of steel
- Ideal for closets, garages, sheds or any shelving needs
- Compatible with wood, plastic, or metal shelves



Wall Brackets

Item Code	Size	Metal Thickness	INN	CTN
WB0068	6" x 8"	0.7 mm	12	120 Pairs
WB0810	8" x 10"	0.7 mm	12	72 Pairs
WB1012	10" x 12"	0.8 mm	12	60 Pairs
WB1214	12" x 14"	0.8 mm	12	60 Pairs



Caster Wheels

Item Code	Size	Max Load	INN	CTN
BRCW0025	1"	25 lbs	20	200
BRCW0032	1¼"	45 lbs	20	180
BRCW0040	1½"	80 lbs	20	160
BRCW0050	2"	84 lbs	15	150
BRCW0075	3"	132 lbs	6	48
BRCW0125	5"	220 lbs	4	24

- Flat type
- Swivel base with roller bearing
- Black rubber material



CABLE CLIPS

Flat Cable Clips

Item Code	Size	QTY	INN	CTN
CHF9MM	1.5 mm	100 PCS/Bag	10 Bags	200 Bags
CHF10MM	2.5 mm	100 PCS/Bag	10 Bags	200 Bags
CHF12MM	4 mm	100 PCS/Bag	10 Bags	150 Bags
CHF14MM	6 mm	100 PCS/Bag	10 Bags	150 Bags

- Concrete nail included



Cable Clips

Item Code	Size	QTY	INN	CTN
NC0407	4-7 mm	100 PCS/Bag	10 Bags	100 Bags
NC0508	5-8 mm	100 PCS/Bag	10 Bags	100 Bags
NC0610	6-10 mm	100 PCS/Bag	10 Bags	100 Bags

- Concrete nail included



GATE ACCESSORIES

Roller Guides

Item Code	Diameter	Length	CTN
BRGH5580W	2"	3½"	24

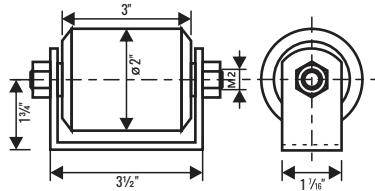

Item Code	D	H	H1	M	INN	CTN
BRGH3040W	1¼"	1⅝"	3"	0.4"	12	72
BRGH4060W	1⅝"	2⅞"	3"	0.5"	12	72



L Bracket

Item Code	Length	Height	INN	CTN
BRGHBOOL	5⅝"	3"	12	72

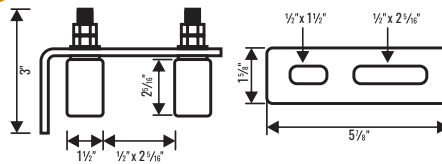

Guide Wheel

Item Code	Height	Description	INN	CTN
BRGHS1003	3"	V Groove Single Bearing	6	24

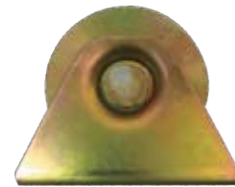
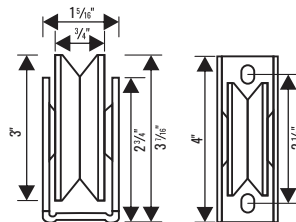

Item Code	Size	Description	INN	CTN
BRGHD2003	3"	V Groove Double Bearing	6	24

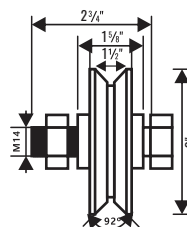

GATE ACCESSORIES



Metal Door Lock Cases

Item Code	Description	Hole Size	Width	Length	INN	CTN
BRMB001	Single	54 mm	89 mm	139 mm	6	60
BRMB002	Double	54 mm	137 mm	171 mm	6	30

Item Code	Description	Hole Size	Width	Length	INN	CTN
BRMB001EP	Single	54 mm	89 mm	139 mm	6	60
BRMB002EP	Double	54 mm	137 mm	171 mm	6	30

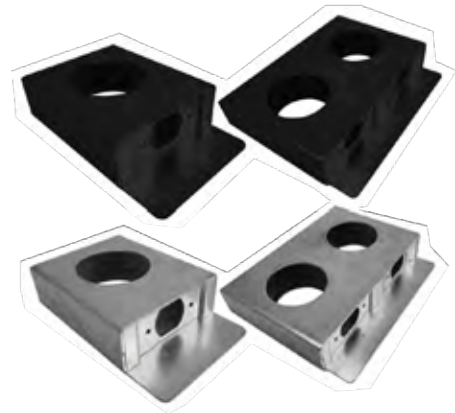

Heavy Duty Gate Hinges

Item Code	Size	INN	CTN
BRHD001	6"	2 Pairs	10 Pairs
BRHD002	4"	2 Pairs	20 Pairs

Grease zerk fitting to keep internal ball bearings lubricated



Piston Hinges

Item Code	Size	INN	CTN
BRPH0003	3"	30	300
BRPH0004	4"	20	200
BRPH0005	5"	10	100
BRPH0006	6"	10	60

Grease zerk fitting to keep internal ball bearings lubricated



HASPS & STAPLES

Hasps and Staples

Item Code	Size	Finish	INN	CTN
BRBJ00250	2½"	Black	12	600
BRBJ00300	3"	Black	12	480
BRBJ00400	4"	Black	12	300
BRBJ00500	5"	Black	12	144
BRZ00250	2½"	Zinc Plated	12	600
BRZ00300	3"	Zinc Plated	12	480
BRZ00400	4"	Zinc Plated	12	300

- Vertical and horizontal use
- For doors and windows
- Indoor and outdoor use



Self-Locking Hasps and Staples

Item Code	Size	INN	CTN
BBSLH030	3"	12	120
BBSLH040	4"	12	72

- Vertical and horizontal use
- For doors and windows
- Indoor and outdoor use
- Includes keys

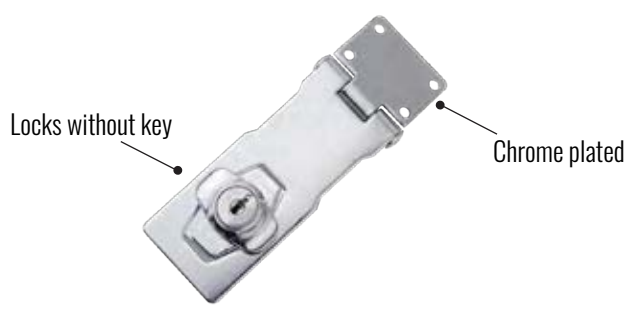

TOWER BOLTS

Flush Bolt

Item Code	Size	INN	CTN
BRFB008SS	8"	24	96

- Rust-resistant



Tower Bolts

Item Code	Size	Finish	INN	CTN
BRACP2000	2"	Aluminum	12	600
BRACP2500	2½"	Aluminum	12	480
BRACP3000	3"	Aluminum	12	480
BRACP4000	4"	Aluminum	12	240
BRACP5000	5"	Aluminum	12	240

- Includes screws

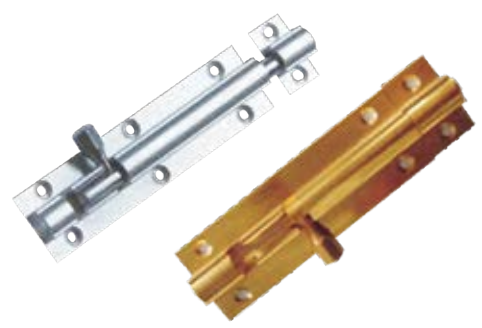

Zinc Tower Bolts

Item Code	Size	Finish	INN	CTN
BRTB100	2½"	Yellow Zinc	12	96
BRTB200	2½"	Chrome Zinc	12	96
BRTB300	3"	Yellow Zinc	12	96
BRTB400	3"	Chrome Zinc	12	96
BRTB500	4"	Yellow Zinc	12	96
BRTB600	4"	Chrome Zinc	12	96

- Vertical and horizontal use
- For doors and windows
- For indoor and outdoor use



Heavy Duty Flat Tower Bolts

Item Code	Size	INN	CTN
HDFDB003	3"	12	120
HDFDB004	4"	12	120
HDFDB005	5"	12	60

- Extra protection
- For all types of enclosures

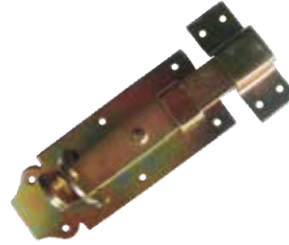

Heavy Duty Tower Bolts

Item Code	Size	Finish	INN	CTN
3000BPSC	3"	Brass Plated	12	120
3002BPSC	4"	Brass Plated	12	60
3003BPSC	5"	Brass Plated	12	60
3004BPSC	6"	Brass Plated	12	60
3006BJSC	3"	Black Japanned	12	120
3008BJSC	4"	Black Japanned	12	60
3009BJSC	5"	Black Japanned	12	60
3010BJSC	6"	Black Japanned	12	60

- Vertical and horizontal use
- For doors and windows
- For indoor and outdoor use

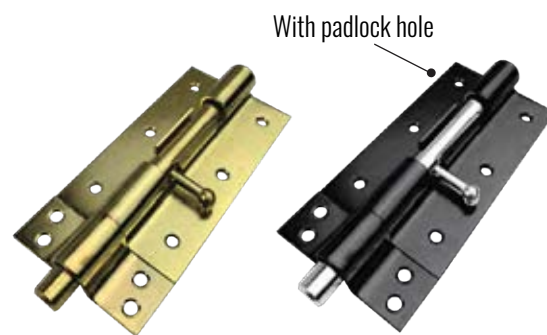

HOOKS

Hammock Hook

Item Code	Size	QTY	INN	CTN
BRHH004	4"	Pairs	6	72

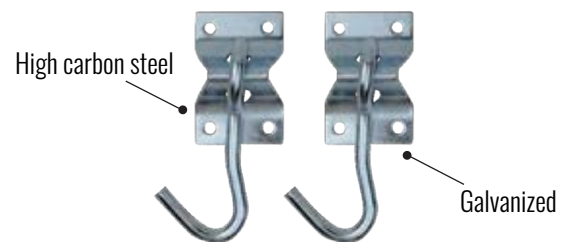

Picture Hooks

Item Code	Size	INN	CTN
BRPH30	30 mm	100	400
BRPH40	40 mm	100	400

- Made of sturdy and durable plastic



DOOR LOCKS

Entry Door Locks and Deadbolts

Item Code	Finish	INN	CTN
BRAB71	Antique Brass	6	12
BRAC71	Antique Copper	6	12
BRPB71	Polished Brass	6	12
BRSS71	Stainless Steel	6	12



Item Code	Finish	INN	CTN
BRAB71T	Antique Brass	6	12
BRAC71T	Antique Copper	6	12
BRSS71T	Stainless Steel	6	12

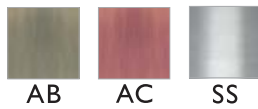

Item Code	Finish	INN	CTN
BRSS71L	Stainless Steel	6	12



Item Code	Finish	INN	CTN
BRSS81L	Stainless Steel	6	12



- Certified security
- Tubular mechanism
- High security cylinder
- Fits all doors 1 1/4" - 2" thick
- Same key opens both locks
- Meets ANSI grade 3 standards
- Adjustable backset fits both 2 3/8" - 2 3/4"



COMBO SETS

Entry Door Locks and Double Deadbolts

Item Code	Finish	INN	CTN
BRAB72	Antique Brass	6	12
BRAC72	Antique Copper	6	12
BRPB72	Polished Brass	6	12
BRSS72	Stainless Steel	6	12



Item Code	Finish	INN	CTN
BRAB72T	Antique Brass	6	12
BRAC72T	Antique Copper	6	12
BRSS72T	Stainless Steel	6	12

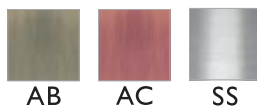

Item Code	Finish	INN	CTN
BRSS72L	Stainless Steel	6	12



Item Code	Finish	INN	CTN
BRSS82L	Stainless Steel	6	12



- Certified security
- Tubular mechanism
- High security cylinder
- Fits all doors 1¼" - 2" thick
- Same key opens both locks
- Meets ANSI grade 3 standards
- Adjustable backset fits both 2¾" - 2¾"



Double Deadbolt Locks

Item Code	Finish	INN	CTN
BRAB02	Antique Brass	6	24
BRAC02	Antique Copper	6	24
BRPB02	Polished Brass	6	24
BRSS02	Stainless Steel	6	24



- Meets ANSI grade 3 standards
- Adjustable backset fits both 2³/₈" - 2³/₄"

Double Deadbolt Locks

Item Code	Finish	INN	CTN
BRABCS02	Antique Brass	6	24
BRSSCS02	Stainless Steel	6	24

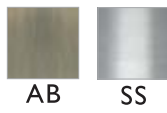

- Meets ANSI grade 3 standards
- Adjustable backset fits both 2³/₈" - 2³/₄"



Deadbolt Locks

Item Code	Finish	INN	CTN
BRAB01	Antique Brass	6	24
BRAC01	Antique Copper	6	24
BRPB01	Polished Brass	6	24
BRSS01	Stainless Steel	6	24



- Fits all doors 1¹/₄" - 2" thick
- Same key opens both locks
- Meets ANSI grade 3 standards
- Adjustable backset fits both 2³/₈" - 2³/₄"

Lever Entry Door Lock

Item Code	Finish	INN	CTN
BRSS7OEL	Stainless Steel	6	24



- Fits all doors 1¹/₄" - 2" thick
- Meets ANSI grade 3 standards
- Heavy duty solid brass cylinder
- Tubular mechanism

Lever Entry Door Lock

Item Code	Finish	INN	CTN
BRSS80EL	Stainless Steel	6	24

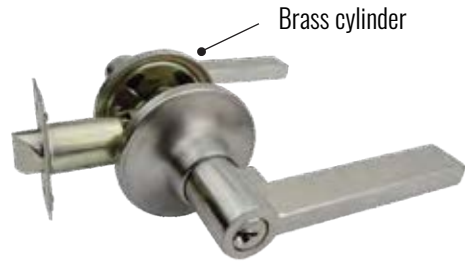

- Fits all doors 1 1/4" - 2" thick
- Meets ANSI grade 3 standards
- Heavy duty solid brass cylinder
- Tubular mechanism

Lever Passage Door Lock

Item Code	Finish	INN	CTN
BRSS70PAL	Stainless Steel	6	24



Knob Passage Door Locks

Item Code	Finish	INN	CTN
BRAB70PA	Antique Brass	6	12
BRSS70PA	Stainless Steel	6	12

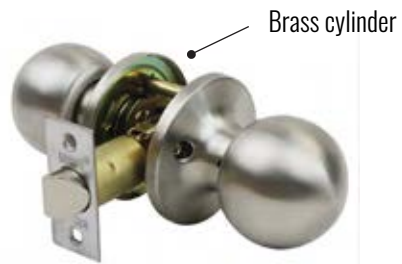

- Fits all doors 1 3/8" - 2" thick
- Certified security
- Meets ANSI grade 3 standards
- Universal latch 2 3/8" - 2 3/4"

Entry Door Locks

Item Code	Finish	INN	CTN
BRAB70E	Antique Brass	6	24
BRAC70E	Antique Copper	6	24
BRPB70E	Polished Brass	6	24
BRSS70E	Stainless Steel	6	24

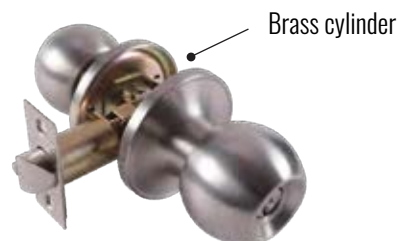

- Fits all doors 1 1/4" - 2" thick
- Meets ANSI grade 3 standards

Entry Door Locks

Item Code	Finish	INN	CTN
BRAB70ET	Antique Brass	6	24
BRAC70ET	Antique Copper	6	24
BRSS70ET	Stainless Steel	6	24

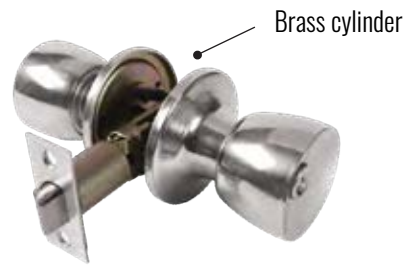
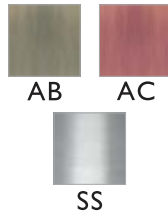

- Fits all doors 1¼" - 2" thick
- Meets ANSI grade 3 standards
- Tubular mechanism

Entrance Handle Sets

Item Code	Finish	CTN
BR805871AB	Antique Brass	6
BR805871AC	Antique Copper	6
BR805871SS	Stainless Steel	6

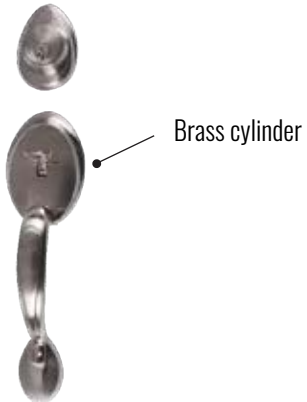
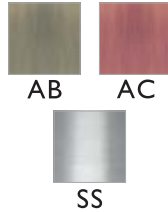

- Fits all doors 1¾" to 2" thick
- Includes 3 solid brass keys
- Includes 5 solid brass tumbler pins

Item Code	Finish	CTN
BR821871AB	Antique Brass	6
BR821871AC	Antique Copper	6
BR821871SS	Stainless Steel	6

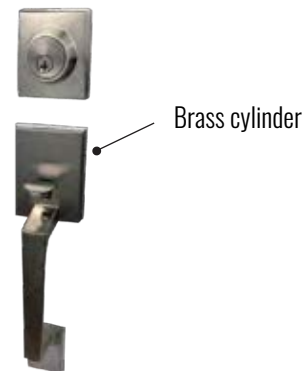
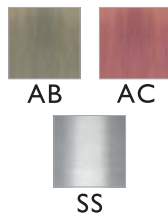

- Fits all doors 1¾" to 2" thick
- Includes 3 solid brass keys
- Includes 5 solid brass tumbler pins

Privacy Door Locks

Item Code	Finish	INN	CTN
BR70ABP	Antique Brass	6	24
BR70ACP	Antique Copper	6	24
BR70PBP	Polished Brass	6	24
BR70SSP	Stainless Steel	6	24

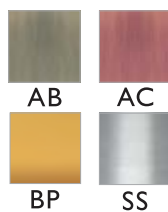

- Certified security
- Tubular mechanism
- High security cylinder
- Fits all doors 1¼" - 2" thick
- Meets ANSI grade 3 standards

Privacy Door Locks

Item Code	Finish	INN	CTN
BR70ABPT	Antique Brass	6	24
BR70SSPT	Stainless Steel	6	24

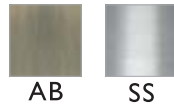

Item Code	Finish	INN	CTN
BRSS70PL	Stainless Steel	6	24



Item Code	Finish	INN	CTN
BRSS80PL	Stainless Steel	6	24



- Certified security
- Tubular mechanism
- High security cylinder
- Fits all doors 1 1/4" - 2" thick
- Meets ANSI grade 3 standards

PADLOCKS

Solid Brass Padlocks

Item Code	Size	Security Level	No. Pins	Shackle & Lock Body Dimensions (mm)							INN	CTN
				A	B	C	D	E	F			
BR401	3/4"	-	4	21	21	11.1	3.3	10.7	10.5	6	72	
BR403	1"	4	4	30	27	16	5	15	13	6	36	
BR404	1 1/2"	6	5	40	33	21.8	6.3	20.7	14	6	36	
BR405	2"	7	6	50	39	25	8	26	16	6	24	
BR406	2 3/8"	9	6	60	45	32	10	31	18.5	6	24	

- Hardened chrome plated shackle
- Rust-resistant solid brass body
- Stainless steel springs
- Dual-locking device
- Solid brass pin

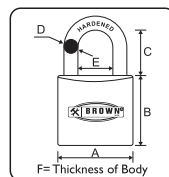

3 brass keys included



Heavy Duty Padlocks

Shackle & Lock Body Dimensions (mm)

Item Code	Size	Security Level	No. Pins	A	B	C	D	E	F	INN	CTN
NA9865S	2 1/2"	9	5	65	56	40	11	23.5	28	6	36
NA9865L	2 1/2"	9	5	65	56	58	11	23.5	28	6	36

- Solid steel
- Hardened chrome plated shackle, steel cylinder guard plate, and security nut
- Solid brass cylinder and pins
- Drain hole prevents corrosion

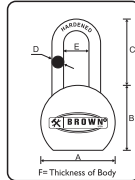

3 brass keys included

Available in black

Extra long shackle



3 brass keys included

Shackle & Lock Body Dimensions (mm)

Item Code	Size	Security Level	No. Pins	A	B	C	D	E	F	INN	CTN
NA9865BK	2 1/2"	9	5	65	56	40	11	23.5	28	6	36
NA9865BL	2 1/2"	9	5	65	56	58	11	23.5	28	6	36

Weather-Resistant Padlocks

Shackle & Lock Body Dimensions (mm)

Item Code	Size	Security Level	No. Pins	A	B	C	D	E	F	INN	CTN
BRLWR40	1 1/2"	5	4	47	39	24	10	7.3	25.5	6	60
BRLWR50	2"	7	5	58	47	26.5	24.5	9.5	30	6	60



3 brass keys included



Shackle & Lock Body Dimensions (mm)

Item Code	Size	Security Level	No. Pins	A	B	C	D	E	F	INN	CTN
BRLWR40L	1 1/2"	5	4	47	38	51	7	19	21	6	60
BRLWR50L	2"	7	5	58	47	56	9.5	24.7	25	6	60



3 brass keys included

Extra long shackle



- Thermoplastic cover
- Includes 3 brass keys
- Hardened steel shackle
- Patented dual-locking levers

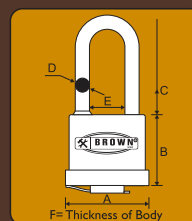

Disc Padlocks

Item Code	Size	Security Level	No. Pins	Shackle & Lock Body Dimensions (mm)							
				A	C	D	E	F	INN	CTN	
BRD060	2 3/8"	9	5	60	13	8	18	25	12	72	
BRD070	2 3/4"	9	5	70	18	9	22	25	12	72	
BRD080	3 1/8"	10	5	80	19	12	26	29	6	48	

- Keyed alike



2 brass keys included



Item Code	Size	Security Level	No. Pins	Shackle & Lock Body Dimensions (mm)							
				A	C	D	E	F	INN	CTN	
BRD0702KA	2 3/4"	9	5	70	18	9	22	25	6 Sets	36 Sets	

- Keyed alike

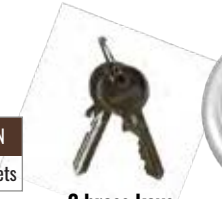

2 brass keys included



Item Code	Size	Security Level	No. Pins	Shackle & Lock Body Dimensions (mm)							
				A	C	D	E	F	INN	CTN	
BRD0704KA	2 3/4"	9	5	70	18	9	22	25	3 Sets	18 Sets	

- Keyed alike

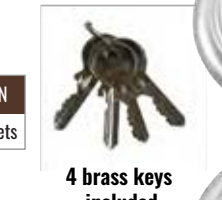

4 brass keys included



- Brass cylinder
- Solid brass pins
- Hardened steel shackle
- Stainless steel lock body is water-resistant and anticorrosive

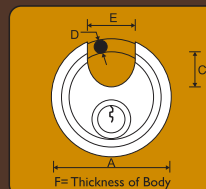

Laminated Steel Padlocks

Shackle & Lock Body Dimensions (mm)

Item Code	Size	Security Level	No. Pins	A	B	C	D	E	F	INN	CTN
BRL0030	1"	3	4	36.2	29	16	5.0	15	22.5	6	120
BRL0040	1½"	5	4	44	35	21	6.3	20.7	26	6	60
BRL0050	2"	7	5	56.8	42.5	25	9	25	32.4	6	60
BRL0060	2¾"	8	5	68.2	51.5	32.8	10.5	32.5	36.9	6	36



2 brass keys included



Shackle & Lock Body Dimensions (mm)

Item Code	Size	Security Level	No. Pins	A	B	C	D	E	F	INN	CTN
BRL400L	1½"	5	4	46	36	51	6.3	20.5	25	6	60
BRL500L	2"	7	5	55	42	60	8	26	28.4	6	60
BRL600L	2¾"	8	5	75	56	80	12	33	42	6	36



2 brass keys included



↑
Extra long shackle

Shackle & Lock Body Dimensions (mm)

Item Code	Size	Security Level	No. Pins	A	B	C	D	E	F	INN	CTN
BRL0040KA	1½"	5	4	44	35	21	6.3	20.7	26	6 Sets	24 Sets
BRL0050KA	2"	7	5	56.8	42.5	25	9	25	32.4	6 Sets	24 Sets

- Keyed alike



4 brass keys included



Shackle & Lock Body Dimensions (mm)

Item Code	Size	Security Level	No. Pins	A	B	C	D	E	F	INN	CTN
BRL400LKA	1½"	5	4	46	36	51	6.3	20.5	25	6 Sets	24 Sets
BRL500LKA	2"	7	5	55	42	60	8	26	28.4	6 Sets	24 Sets

- Keyed alike



4 brass keys included



↑
Extra long shackle



↑
Extra long shackle

- Solid brass pins
- High security lock
- Stainless steel springs
- Wide laminated steel body
- Keyed alike for convenience
- Hardened chrome plated shackle

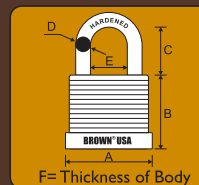

F= Thickness of Body

SPECIAL LOCKS

Drawer Lock

Item Code	Size	INN	CTN
BRHDL0016B	18 mm	6	120

- For cabinets, drawers, and desks
- Includes 1 lock and 2 keys



Sliding Glass Lock

Item Code	Size	INN	CTN
BRHGCL0028B	5 1/2"	6	60

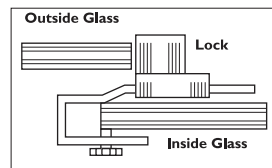

Drawer Lock

Item Code	Size	INN	CTN
NA631	3/4"	12	240



Door Closers

Item Code	Shape	INN	CTN
BRDC001	Square	1	10
BRDC002	Round	1	10

- Door capacity: 120 lbs
- Suitable for left and right hand doors
- Up to 500,000 uses

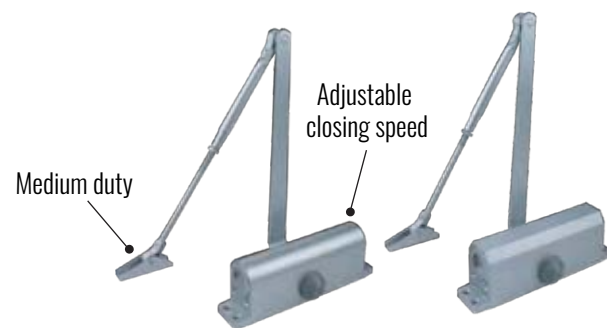

Door Closer

Item Code	Description	INN	CTN
BRDC505BC	#5 Overhead Hydraulic	1	10

- Door capacity: 265 lbs
- For commercial use
- Up to 500,000 uses

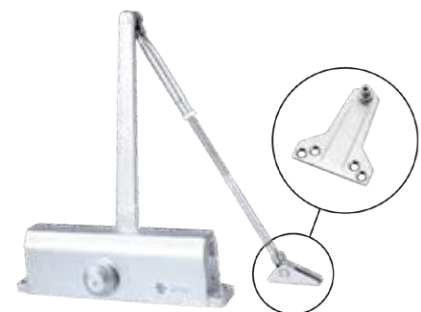

Corner mounting bracket



Duct Tapes

Item Code	Size	INN	CTN
DT210	2" x 10 yds	48	48
DT230	2" x 30 yds	24	24
DT260	2" x 60 yds	24	24

- Adhesion to a wide variety of surfaces, such as: cloth, vinyl, leather, plastic, and metal



Packing Tapes

Item Code	Size	Color	INN	CTN
PT004	2" x 55 yds	Clear	6	72
PT008	2" x 55 yds	Tan	6	72

- For general purposes

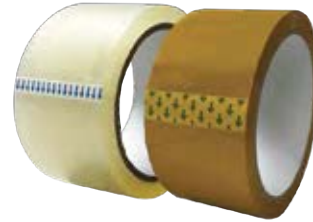

Painter's Masking Tape

Item Code	Size	Color	CTN
PT260	1 1/8" x 60 yds	Blue	24

- For interior and exterior use
- UV-resistant
- Medium adhesion



Masking Tapes

Item Code	Size	Color	CTN
MT0160	1" x 60 yds	White	36
MT0260	2" x 60 yds	White	24
MT11260	1 1/2" x 60 yds	White	24
MT3460	3/4" x 60 yds	White	48

- Easy to remove
- Will not damage surfaces nor leave behind sticky residue



Grounding Clamp

Item Code	Amps	INN	CTN
300AMP	300	1	100

- Zinc plated



Welder's Soapstone

Item Code	Type	Size	INN	CTN
BRSC1000	Flat	5" x 1/2"	1	12

- Flat, white
- Professional quality



Carpenter Pencil

Item Code	Type	Size	INN	CTN
CP007	Oval	7"	20	200

- 6 pencils per package



Clotheslines

Item Code	Size	INN	CTN
BRCL010	3 mm x 10 m	25	100
BRCL020	3 mm x 20 m	25	50

- Plastic coating protects against rain and other weather



ELECTRODE HOLDERS

Heavy Duty Electrode Holders

Item Code	Power	INN	CTN
BREH300	300 AMPS	12	24
BREH500	500 AMPS	12	24

Heat-resistant polyester with fiberglass coating



Gas Hose

Item Code	Length	INN	CTN
BRGH001	100'	2	2



Reinforced Gas Hose

Item Code	Length	INN	CTN
BRGH002	100'	2	2



CONTAINERS

Plastic Gasoline Containers

Item Code	Size	CTN
BR50805	1.25 gal	8
BR50810	2.5 gal	5
BR50833	5 gal	4



AVIATION SNIPS

Aviation Snips (Left Cut)

Item Code	Size	INN	CTN
BRAVS001	10"	6	60



Cutting Capacity:



Aviation Snips (Right Cut)

Item Code	Size	INN	CTN
BRAVS002	10"	6	60



Cutting Capacity:



Aviation Snips (Straight Cut)

Item Code	Size	INN	CTN
BRAVS003	10"	6	60



Cutting Capacity:



Bolt Cutters

Item Code	Size	INN	CTN
BRBC0014	14"	1	10
BRBC0018	18"	1	10
BRBC0024	24"	1	10
BRBC0036	36"	1	5

- Heat-treated
- Hardened and tempered

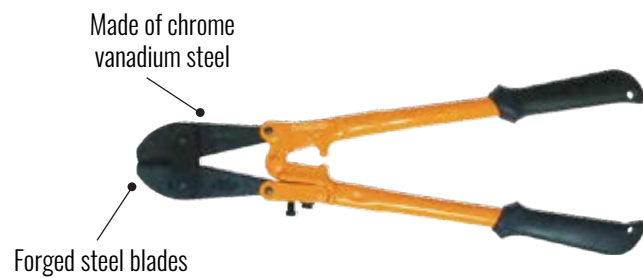

CHISELS

Heavy Duty Flat Chisels

Item Code	Shank	Cutting Edge	Length	CTN
BRSC009	1/2"	5/8"	6"	30
BRSC002	1/2"	5/8"	8"	30
BRSC003	5/8"	3/4"	8"	30
BRSC012	1/8"	1"	8"	24
BRSC013	1"	1 1/4"	8"	30
BRSC014	1/2"	5/8"	10"	30

Made of chrome vanadium steel



Heavy Duty Pointed Chisel

Item Code	Shank	Length	CTN
BRSC004	3/4"	12"	30

Made of chrome vanadium steel



Heavy Duty Brick Chisel with Grip

Item Code	Shank	Cutting Edge	Length	CTN
BRSC005	1/8"	3"	8"	10

Made of chrome vanadium steel

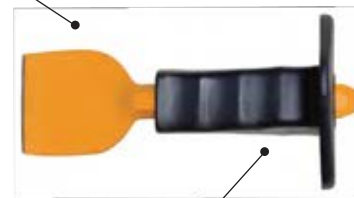

Shock-absorbent handle

Heavy Duty Flat Chisels with Grip

Item Code	Shank	Cutting Edge	Length	CTN
BRSC006	3/4"	1/8"	12"	10
BRSC008	3/4"	1"	12"	10

Made of chrome vanadium steel



Shock-absorbent handle

Wood Chisels

Item Code	Size	INN	CTN
BR14602	3/8"	6	36
BR14603	1/2"	6	36
BR14604	3/4"	6	36
BR14605	1"	6	36
BR14606	1 1/4"	6	36
BR14607	1 1/2"	6	36
BR14609	7/8"	6	36

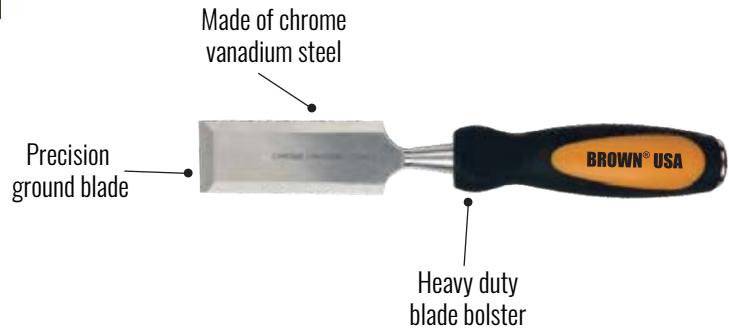

10 PCS Hex Key Set

Item Code	Finish	INN	CTN
BRHEX01	Black Oxide	6	48
BRHEX02	Silver	6	48



- L-style hex keys in convenient caddy set
- Sizes: 1.5 mm - 2 mm - 2.5 mm - 3 mm - 4 mm - 5 mm - 6 mm - 8 mm - 10 mm

HEX WRENCH



End Nipper Plier

Item Code	Size	INN	CTN
BREN008	8"	6	48

- 3x more rust-resistant

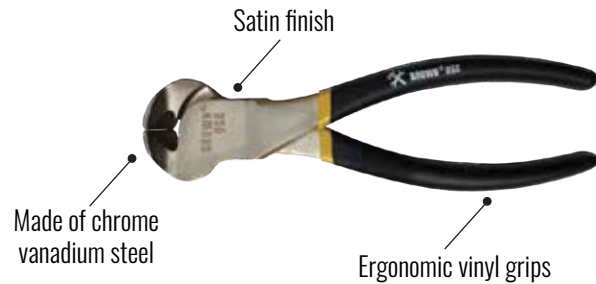

Tile Nipper

Item Code	Size	INN	CTN
BRTL080	8"	6	48

Tungsten carbide teeth for longer cutting life



PIPE CUTTER

PVC Pipe Cutter

Item Code	Cutting Range	INN	CTN
BRPVC1	1 5/8"	6	48

- Ideal for electrical installation, sprinkler systems, and general plumbing
- Smooth and quick cuts



PLIERS

Diagonal Cutting Pliers

Item Code	Size	INN	CTN
BRDC006	6"	6	60
BRDC008	8"	6	48

- 3x more rust-resistant

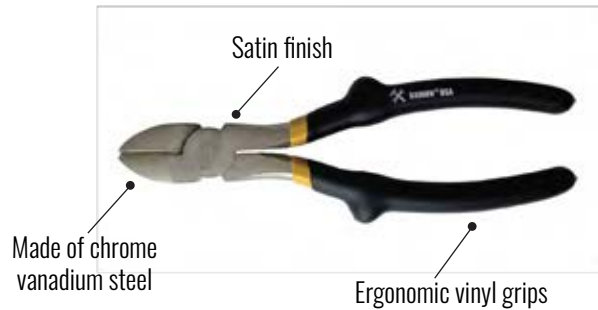

Groove Joint Pliers

Item Code	Size	INN	CTN
BRGJ010	10"	6	48
BRGJ012	12"	6	24

- 3x more rust-resistant



Linesman Pliers

Item Code	Size	INN	CTN
BRCP006	6"	6	60
BRCP008	8"	6	48

- 3x more rust-resistant

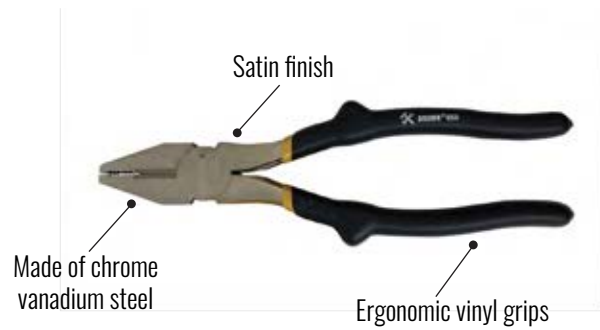

Long Nose Pliers

Item Code	Size	INN	CTN
BRLN006	6"	6	60
BRLN008	8"	6	48

- 3x more rust-resistant

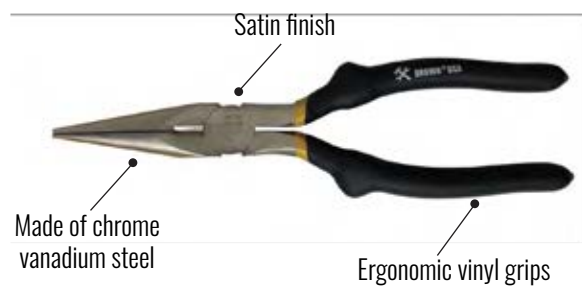

Slip Joint Pliers

Item Code	Size	INN	CTN
BRSJ006	6"	6	60
BRSJ008	8"	6	60

- 3x more rust-resistant

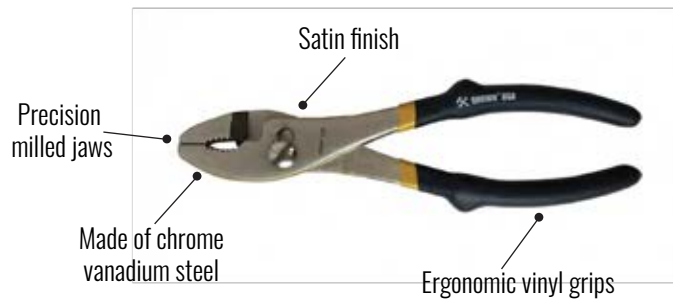

Curved Jack Locking Pliers

Item Code	Size	INN	CTN
BRLP001	7"	3	36
BRLP002	10"	3	36

- For tightening, clamping, twisting, and turning

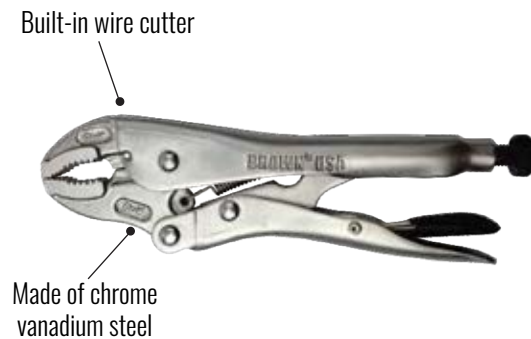

Straight Jaw Locking Pliers

Item Code	Size	INN	CTN
BRLP003	7"	3	36
BRLP004	10"	3	36

- For tightening, clamping, twisting, and turning



Made of chrome vanadium steel

RIVET TOOL

Rivet Gun

Item Code	Size	INN	CTN
RIV7022	9 1/2"	6	24

- Rivets include:

- 3/32" (2.4mm) - 10 PCS
- 1/8" (3.2mm) - 10 PCS
- 5/32" (4.0mm) - 10 PCS
- 3/16" (4.8mm) - 10 PCS



SAWS

Hacksaw

Item Code	Size	TPI	INN	CTN
ATHF02	12"	24	6	36

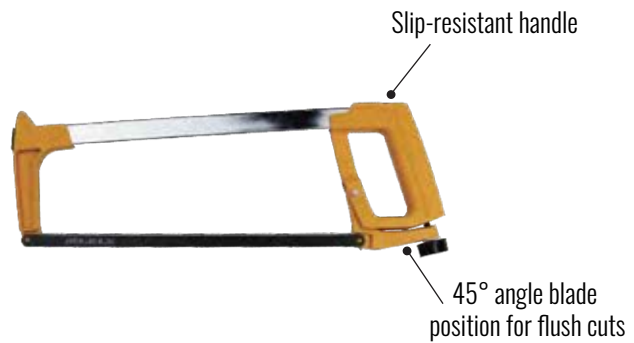

Mini Hacksaw

Item Code	Size	INN	CTN
ATHF20	6"	12	120

- Ideal for cutting in confined areas



Adjustable Bi-Metal Hacksaw

Item Code	Size	TPI	INN	CTN
BRHF001	12"	24	6	24

- 2 saw positions for 90° and 180° cuts
- Adjustable to 8", 10", and 12"

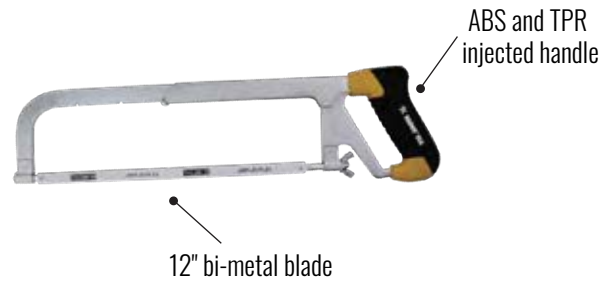

Adjustable Metal Hacksaw

Item Code	Size	TPI	INN	CTN
BRHF006	12"	24	6	36

- 2 saw positions for 90° and 180° cuts
- Adjustable to 10" and 12"
- ABS injected handle

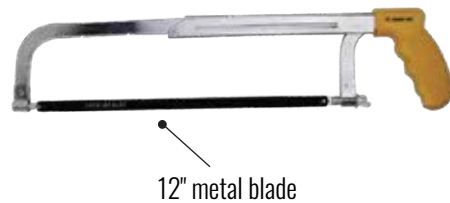

Handi-Cut Mini Hacksaw

Item Code	Size	INN	CTN
BRHF016	12"	12	72

- Ideal for cutting in confined areas



Drywall Saw

Item Code	Size	TPI	INN	CTN
BRSW312	6"	9	6	48

- 3 cutting angles for faster cutting performance
- Lacquer coating provides 4x better rust protection



MITER BOX

Miter Box

Item Code	Size	CTN
BRMB013	12"	24

Built-in storage slots
safeguard cam pins and pencil

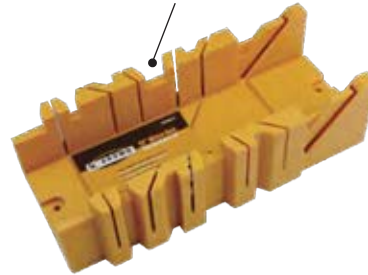

Miter Hand Saw

Item Code	Size	INN	CTN
BRSW313	12"	6	24

- 3 cutting angles for faster cutting performance

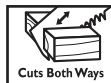

Lacquer coating provides
4x better rust protection



Stable high quality blade
ensures maximum
power transfer

Hand Saws

Item Code	Size	INN	CTN
BRSW314	14"	6	24
BRSW318	18"	6	24
BRSW320	20"	6	24
BRSW322	22"	6	24

- 3 cutting angles for faster cutting performance

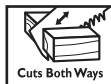

Lacquer coating provides
4x better rust protection



Stable high quality blade
ensures maximum
power transfer

SCREWDRIVERS

Flat Head Screwdrivers

Item Code	Size	INN	CTN
BRSDF004	4" x 1/4"	12	144
BRSDF005	5" x 1/4"	12	144
BRSDF006	6" x 1/4"	12	144
BRSDF008	8" x 1/4"	12	144



- Chrome vanadium steel construction for longevity

Phillips #2 Screwdrivers

Item Code	Size	INN	CTN
BRSDP003	3" x 1/4"	12	144
BRSDP004	4" x 1/4"	12	144
BRSDP005	5" x 1/4"	12	144
BRSDP006	6" x 1/4"	12	144
BRSDP008	8" x 1/4"	12	144



- Chrome vanadium steel construction for longevity

Interchangeable Screwdriver

Item Code	Description	INN	CTN
BR0040	6 in 1	12	120

- Includes:
 - Phillips #1 and #2
 - Flat head 3/16" and 1/4"
 - Hex 1/4" and 5/16"
- Chrome vanadium steel construction for longevity
- Magnetic tip



STRIKING

San Angelo Bar

Item Code	Size	Weight	INN	CTN
SAB072	1" x 72"	17 lbs	6	48

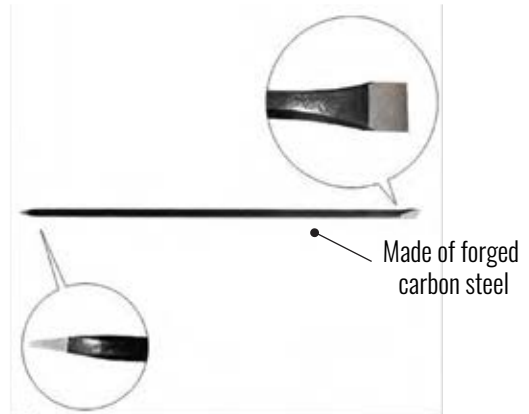

Claw Hammer

Item Code	Weight	INN	CTN
BRAH16	16 oz	6	36



All Steel Carpenter Claw Hammer

Item Code	Weight	INN	CTN
EW0016	16 oz	6	24



Claw Hammers

Item Code	Weight	INN	CTN
FH0016	16 oz	6	24
FH0020	20 oz	6	24



Rubber Mallets

Item Code	Weight	INN	CTN
BRRM0016	16 lbs	6	24
BRRM0024	24 lbs	6	24



Sledge Hammers

Item Code	Weight	INN	CTN
BRS002	2 lbs	6	12
BRS003	3 lbs	6	12
BRS004	4 lbs	6	12
BRS012	12 lbs	1	4



Sledge Hammers

Item Code	Weight	INN	CTN
BSWE03	3 lbs	6	12
BSWE04	4 lbs	6	12
BSWE08	8 lbs	3	6
BSWE10	10 lbs	2	4
BSWE12	12 lbs	1	2
BSWE16	16 lbs	1	2

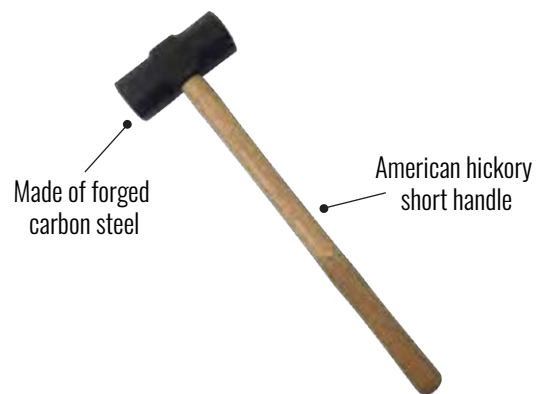

Wrecking Bars

Item Code	Size	Shape	INN	CTN
WBR24	24" x 3/4"	Octagon	6	6
WBR30	30" x 3/4"	Octagon	6	6
WBR36	36" x 3/4"	Octagon	4	4



TIN SNIP

Straight Cut Tinner Snips

Item Code	Size	INN	CTN
BRTIN010	10"	6	60
BRTIN012	12"	6	36

- Precision-ground ensures consistent cutting performance
- Polished finish

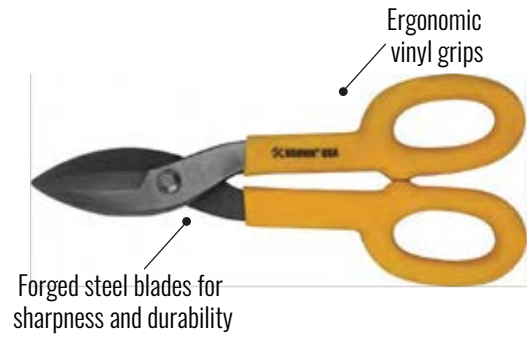

UTILITY KNIVES

Utility Knife

Item Code	INN	CTN
BRUN005	12	72

- Can be used with most utility blades
- Includes 3 blades
- 3 fixed positions



Utility Knife Replacement Blades

Item Code	QTY	INN	CTN
BRUN007	5 PCS	25	500

- Replacement blades for BRUN010 - BRUN005



Foldable Lockback Knife

Item Code	INN	CTN
BRUN010	6	48

- Includes:
 - 1 knife
 - 10 replacement blades
 - 1 holder
- Folding design for safety



WRENCHES

Adjustable Wrenches

Item Code	Size	INN	CTN
BRAW006	6"	6	120
BRAW008	8"	6	60
BRAW010	10"	6	60
BRAW012	12"	6	24

- Chrome plated
- Meets ANSI standards



Made of chrome vanadium steel

Pipe Wrenches

Item Code	Size	INN	CTN
BRPW0010	10"	1	36
BRPW0012	12"	1	24
BRPW0014	14"	1	24
BRPW0080	8"	1	60

- Heat-treated



Made of drop-forged carbon steel

Replaceable jaw



SATIN FINISH

ERGONOMIC VINYL GRIPS



MIXERS

Paint Mixers

Item Code	Size	INN	CTN
PM001	3" x 17" x 8 mm	5	20
PM002	4" x 23 1/2" x 8 mm	6	12
PM003	4 3/4" x 2 1/2" x 10 mm	6	12

- Fits standard drills

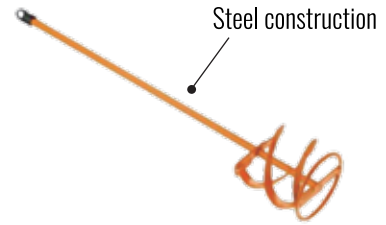

Mortar Mixer

Item Code	Size	INN	CTN
PM004	8" x 30" x 10 mm	4	20

- Fits standard drills

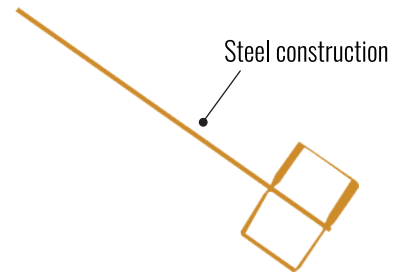

MEASURING

Plastic Chalk Set

Item Code	Size	INN	CTN
BRCL001	100' (30 m)	6	60

- Reel material: high impact plastic
- For vertical and horizontal marking
- Includes red chalk and line reel



Masonry Lines

Item Code	Length	Thickness	Weight	INN	CTN
BRNL3014	50 m	2 mm	1/4 lb	20	120
BRNL3015	100 m	2 mm	1/2 lb	5	30



TILE WORK

Plastic Floats

Item Code	Width	Length	INN	CTN
BRPT5511	5½"	11"	6	36
BRPT595	5"	9½"	6	36
BRPT7125	7"	12½"	6	24
BRPT814	8"	14"	6	24

- Use to smoothly apply grout to floor and wall tile

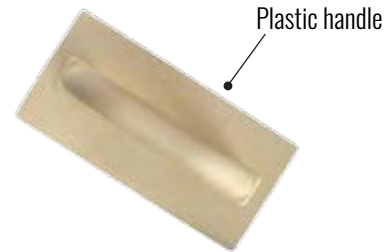

Rubber Cement Floats

Item Code	Width	Length	INN	CTN
BRRF001	4"	9"	6	48
BRRF002	4"	12"	6	48

- For tile grouting, polishing, and cement surfacing



Red Rubber Floats

Item Code	Width	Length	INN	CTN
BRRF003	4"	9½"	12	48
BRRF004	5"	12"	12	48

- For textured finishing on concrete and stucco



Sponge Floats

Item Code	Width	Length	Color	INN	CTN
BRSF01	5"	12"	White	6	48
BRSF02	5"	12"	Green	6	48
BRSF03	5"	12"	Yellow	6	48



- Ideal for cleaning all types of surfaces, particularly ceramic tile installers after fitting, like grouting



Tile Cutter

Item Code	Size	INN	CTN
BRMTC0024	24"	1	4

- Aluminum breaking head
- Tungsten carbide blade
- Straight cutting
- Maximum cutting size: 12 mm



3 in 1 Heavy Duty Tile Cutter

Item Code	Size	INN	CTN
BRMTC0026	24"	1	4

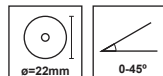

- Aluminum breaking head
- Adjustable face and metal gauge
- Heavy duty carbide scoring wheel & cutter tip
- Rugged cast aluminum frame
- Maximum cutting size: 12 mm

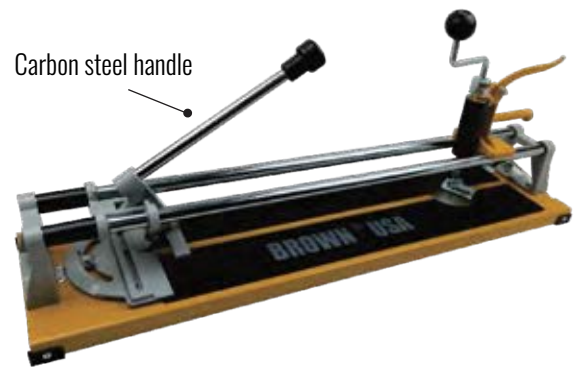

Professional Tile Cutter

Item Code	Size	INN	CTN
BRMTC0029	24"	1	2

- For parallel cuts
- Rubi type
- 500 mm and 600 mm
- Maximum cutting size: 12 mm
- For cutting: tile, porcelain, ceramic, and mosaics



Impact Duty Professional Tile Cutter

Item Code	Size	CTN
BRMTC0032	32"	2



- For parallel and angle cuts
- Die cast cutting with ball bearing for tough and smooth cuts
- Maximum cutting size: 12 mm
- For cutting: ceramic, quarry, fully vitrified terracotta, and porcelain



Tile Cutter Wheels

Item Code	Size	INN	CTN
BRMTC0024WHL	7/8"	100	200
BRMTC0026WHL	7/8"	6	60

- Tungsten carbide scoring edge for clean scoring



Rubber Tile Spacers

Item Code	Size	PCS	INN	CTN
BRTS00014	1/4"	100	1	45
BRTS00018	1/8"	200	1	45
BRTS00116	1/16"	300	1	45
BRTS00316	3/16"	150	1	45



Plastic Tile Spacers

Item Code	Size	PCS	INN	CTN
BRTS002	2 mm	200	1	45
BRTS003	3 mm	200	1	45
BRTS004	4 mm	200	1	45
BRTS005	5 mm	200	1	45



Straight Tile Trim

Item Code	Size	Material	CTN
BRSTA10C	2.6 mm x 10 mm	Chrome	100

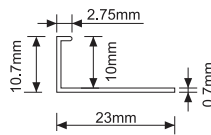

Tile Trims

Item Code	Size	Color	Material	INN	CTN
BRTT08B	2.5 m x 8 mm	Bone	Plastic	100	100
BRTT08W	2.5 m x 8 mm	White	Plastic	100	100
BRTT09B	2.5 m x 9 mm	Bone	Plastic	100	100
BRTT09BL	2.5 m x 9 mm	Black	Plastic	100	100
BRTT09G	2.5 m x 9 mm	Grey	Plastic	100	100
BRTT09W	2.5 m x 9 mm	White	Plastic	100	100
BRTT10B	2.5 m x 10 mm	Bone	Plastic	100	100
BRTT10G	2.5 m x 10 mm	Grey	Plastic	100	100
BRTT10W	2.5 m x 10 mm	White	Plastic	100	100
BRTTA09C	2.6 m x 9 mm	Silver	Aluminum	100	100
BRTTA09G	2.6 m x 9 mm	Gold	Aluminum	100	100
BRTTA10C	2.6 m x 10 mm	Silver	Aluminum	100	100



- For vertical/horizontal and ceramic/marble tile edges
- Trimming at vertical tile intersection
- Protects tile edges from chipping and avoids tile chafing

Tile Trims

Item Code	Size	Color	Material	INN	CTN
BRTTA259C	2.6 m x 10 mm	Silver	Aluminum	25	25
BRTTA259G	2.6 m x 10 mm	Gold	Aluminum	25	25

- For vertical/horizontal and ceramic/marble tile edges
- Trimming at vertical tile intersection
- Protects tile edges from chipping and avoids tile chafing

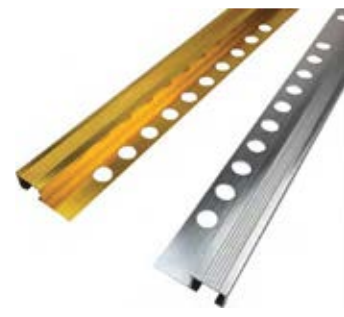

TROWELS

Brick Trowels

Item Code	Size	Thickness	INN	CTN
BRPTR5	5"	1.2 mm	6	48
BRPTR7	7"	1.2 mm	6	48
BRPTR8	8"	1.2 mm	6	48
BRPTR9	9"	1.4 mm	6	48
BRPTR10	10"	1.4 mm	6	48

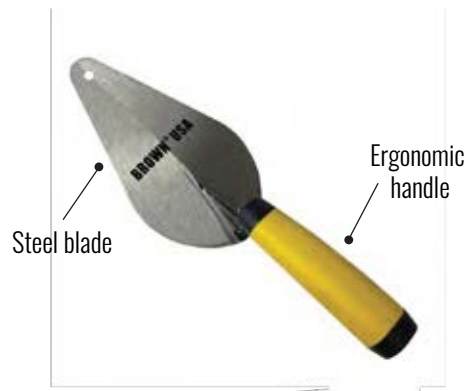

Cement Trowel

Item Code	Size	Thickness	INN	CTN
BRCT115	11" x 5"	0.7 mm	6	48

- Permanently fixed with concealed rivets

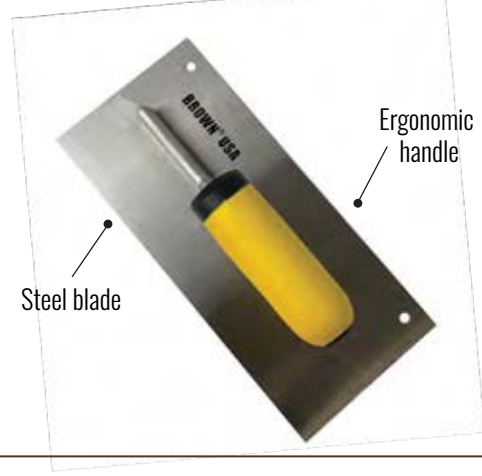

Margin Trowel

Item Code	Size	Thickness	INN	CTN
BRPTRO7	2" x 6"	1.2 mm	6	48

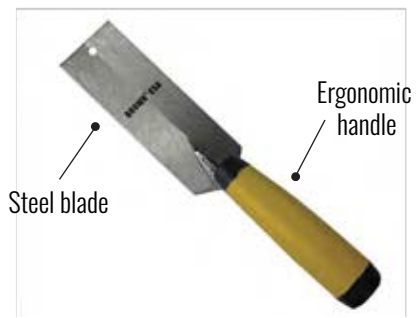

Notch Trowels

Item Code	Size	Square Notch	Thickness	INN	CTN
BRNTR1212	11" x 5"	1/2" x 1/2"	0.7 mm	6	48
BRNTR1234	11" x 5"	1/2" x 3/4"	0.7 mm	6	48
BRNTR1414	11" x 5"	1/4" x 1/4"	0.7 mm	6	48
BRNTR1438	11" x 5"	1/4" x 3/8"	0.7 mm	6	48

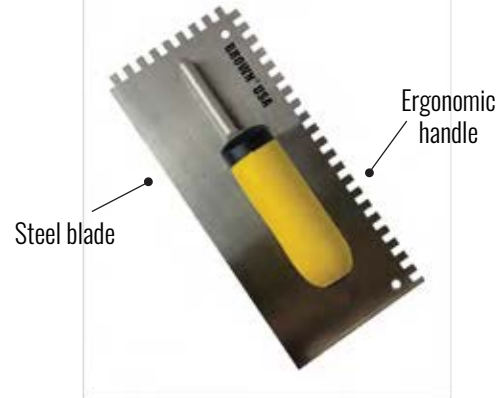

Pointing Trowels

Item Code	Size	Thickness	INN	CTN
BRPTR02	6"	1.2 mm	6	48
BRPTR03	7"	1.2 mm	6	48
BRPTR04	8"	1.2 mm	6	48
BRPTR05	10"	1.4 mm	6	48
BRPTR06	9"	1.4 mm	6	48
BRPTR08	11"	1.4 mm	6	48



Tile Setter Trowel

Item Code	Size	Thickness	INN	CTN
BRTS007	7"	1.2 mm	6	60

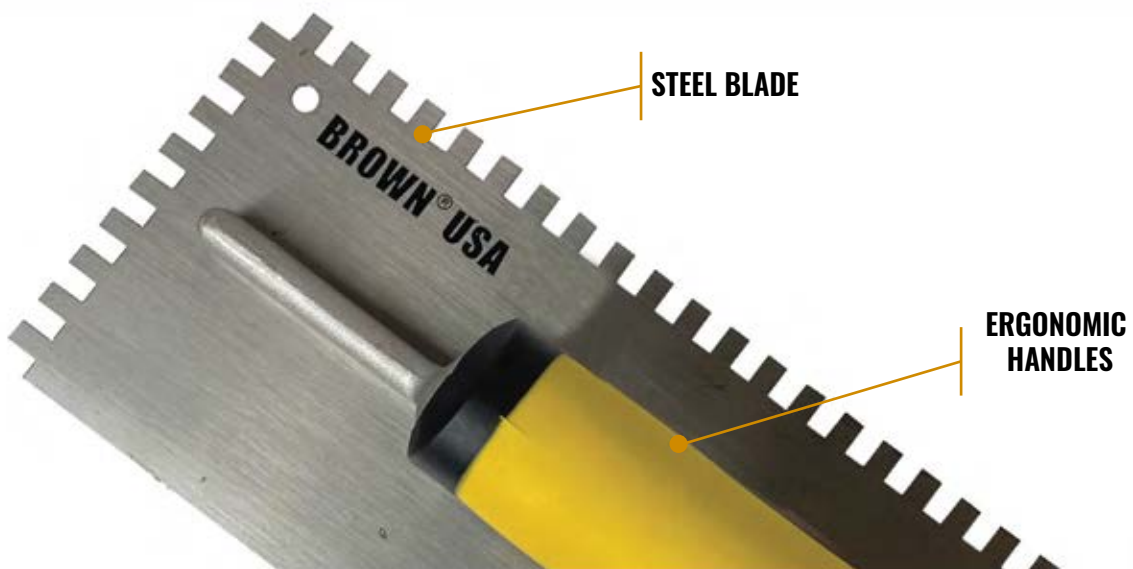
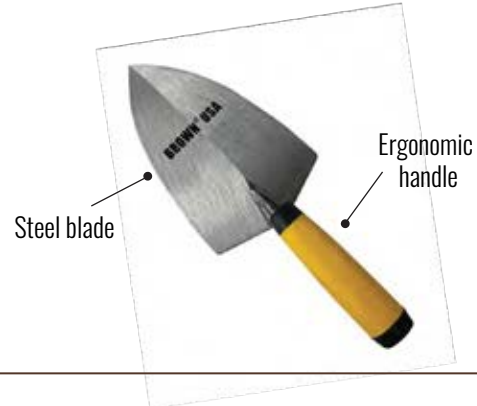

CARPENTER SQUARES

Carpenter Square

Item Code	Size	INN	CTN
SQ0812	8" x 12"	6	24

- Heavy duty

Item Code	Size	INN	CTN
SQ2416	24" x 16"	6	24

- Heavy duty

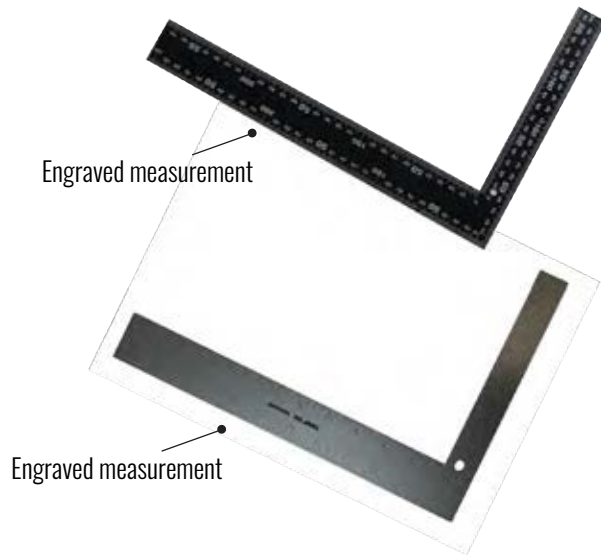

Aluminum Levels

Item Code	Size	INN	CTN
BRLEV24FL	24"	1	24
BRLEV36FL	36"	1	24
BRLEV48FL	48"	1	24
BRLEV72FL	72"	1	24

- Ruled markings in centimeters and inches
- Durable and shock-resistant

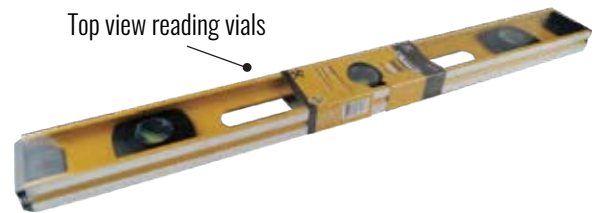

Line Level

Item Code	QTY	INN	CTN
BRLL01	2 Pack	12	120

- 360° vial view



Torpedo Level

Item Code	Size	INN	CTN
BRTORL9	9"	25	50

- Magnetic sides



Combination Square

Item Code	Size	INN	CTN
SQC12	12"	6	60

- Rust-resistant
- Aluminum head

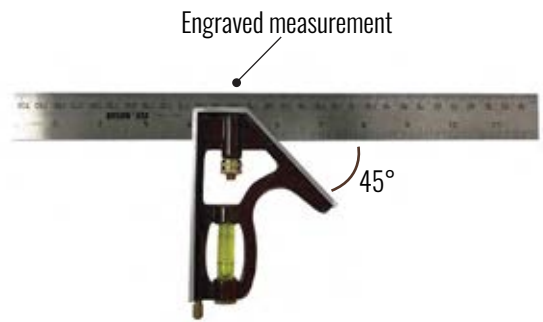

Measuring Tapes

Item Code	Size	INN	CTN
NT1013BL	12' x 5/8"	6	120
NT1036BL	16' x 1"	6	60
NT163BL	25' x 1"	6	48
NT165BL	33' x 1"	6	36



Item Code	Size	INN	CTN
NT16P	16' x 1"	6	60
NT25P	25' x 1"	6	48



MEASURING TAPES



SURVEYOR'S TAPES

Plastic Surveyor's Tapes

Item Code	Size	INN	CTN
SURVEY1	50' x 1/2"	1	60
SURVEY2	100' x 1/2"	1	60



Fiberglass Surveyor's Tape

Item Code	Length	INN	CTN
SURVEY 4	50 m	1	10



BLOW GUNS

Pneumatic Accessory Kits

Item Code	QTY	INN	CTN
BRAA0014	14 PCS	6	12

- Includes:

- 1 recoil air hose with brass fittings
- 2 female quick couplers
- 1 male coupler
- 1 hose connector
- 1 rubber blow gun tip
- 1 inflation needle
- 1 needle adapter
- 1 air chuck
- 1 air blow gun
- 2 quick female connectors
- 2 quick male connectors



Item Code	QTY	INN	CTN
BRAA0015	17 PCS	6	12

-Includes:

- 1 air blow gun
- 1 dual head tire gauge
- 2 1/4" brass male nipples
- 1 brass adapter for air hand nozzle
- 1 high pressure nozzle
- 1 1/4" brass female nipple
- 2 brass female quick connectors
- 4 brass male quick connectors
- 1 pressure gauge
- 1 brass needle tip inflater
- 1 brass inflation valve for balls
- 1 brass female quick coupler



HAND TOOLS

Standard Caulk Gun

Item Code	Size	Gauge	INN	CTN
CG9	9"	23	1	24

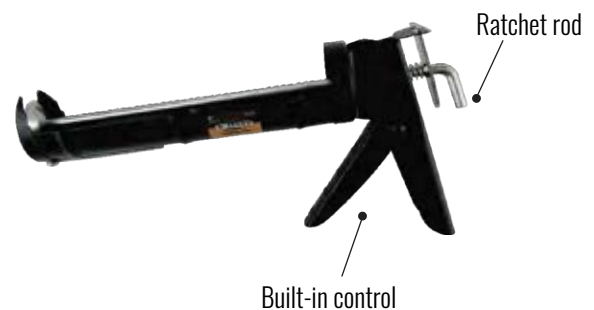

Professional Caulk Gun

Item Code	Size	Gauge	INN	CTN
CG10	9"	20	1	24

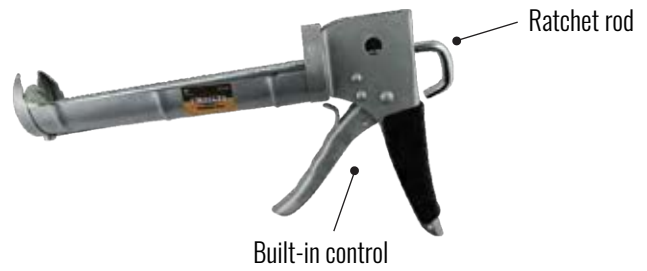

Open Frame Caulk Gun

Item Code	Size	Gauge	INN	CTN
CG11	9"	12	1	24

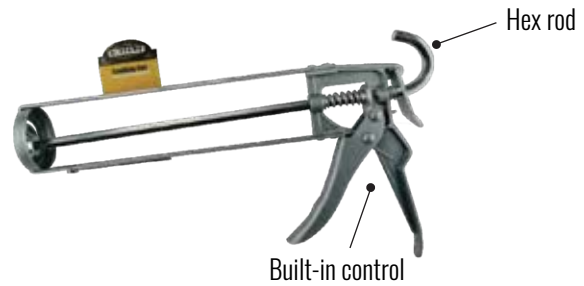

Professional Putty Knife

Item Code	INN	CTN
BRS001	12	120

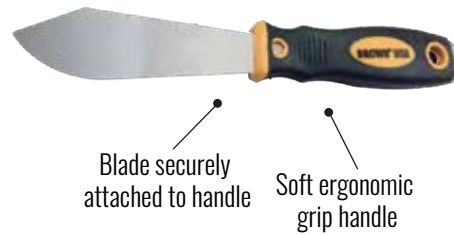

Professional Scrapers

Item Code	Size	INN	CTN
BRS002	2"	12	120
BRS003	3"	12	120
BRS004	4"	12	120
BRS006	6"	12	120



Taping Knives

Item Code	Size	INN	CTN
BRTF008	8"	10	60
BRTF010	10"	6	60

- Blue plated steel

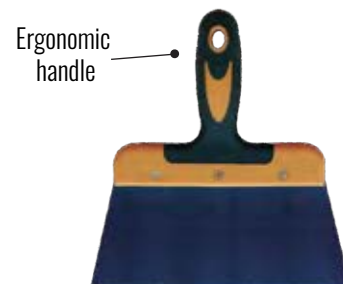

Professional Wire Brushes

Item Code	Row Size	Description	INN	CTN
GBR104	4" x 11"	Without Scraper	6	60
GBR105	4" x 11"	With Scraper	6	60



Ergonomic handle

Professional Wire Brushes

Item Code	Row Size	Description	INN	CTN
GBR106	4" x 11"	Without Scraper	6	60
GBR107	4" x 11"	With Scraper	6	60



Wood handle

Professional Wire Brush

Item Code	Row Size	INN	CTN
GBR108	4" x 16"	6	60

- Stainless steel bristles



SPRAY GUN

Female Quick Coupler

Item Code	Connector	INN	CTN
BRAA0012	Female	6	60

- 1/4" NPT female connector



Low Pressure Paint Spray Gun

Item Code	INN	CTN
SG2000	1	20

- Calibrated brass nozzle creates uniform spray



Working pressure:
50 PSI

High Pressure Paint Spray Gun

Item Code	INN	CTN
SG4000	1	10

- Recommended operating pressure: 75-85 PSI



Working pressure:
90 PSI

Paint Spray Gun

Item Code	Capacity	INN	CTN
SG5000	400 ml	5	10

- Adjustable air control to regulate paint flow
- Type of feed: gravity
- Pattern width: 11-18 cm
- Consumption: 5 CFM



Paint capacity:
400 ml

Standard nozzle:
Ø1.4 mm

Working pressure:
40 PSI

AXES

Camp Axe

Item Code	Weight	Axe Head	Handle	INN	CTN
BRAG0018	1.5 lbs	Forged 1045 High Carbon Steel	American Hickory	12	24



Axe with Handle

Item Code	Weight	INN	CTN
BRAG1023	3.5 lbs	1	1

- Made in Brazil



Axe with Handle

Item Code	Weight	INN	CTN
BRAG1024	4.5 lbs	1	1

- Made in Brazil

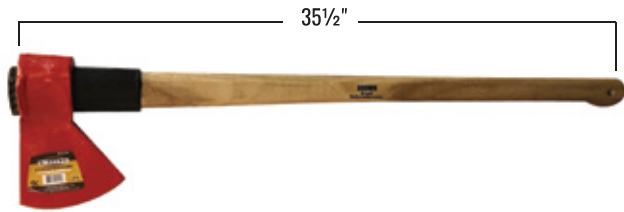

Axe Handle

Item Code	Length	INN	CTN
BRAG5007	35 1/2"	1	1

- Made in Brazil

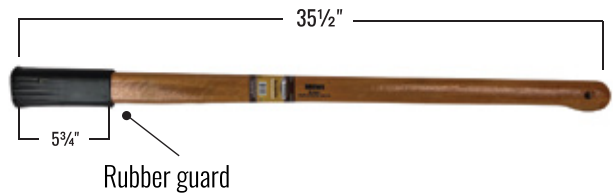

PICK

Pick Mattock

Item Code	Weight	INN	CTN
BRAG0010	5 lbs	6	6

* Handle sold separately



Railroad Picks

Item Code	Weight	INN	CTN
BRAG0011	5 lbs	6	6
BRAG0012	6 lbs	6	6

* Handle sold separately



Railroad Pick

Item Code	Weight	INN	CTN
BRAG1000	5 lbs	1	1

- Made in Brazil



Pick Mattock

Item Code	Weight	INN	CTN
BRAG1001	5 lbs	1	1

- Made in Brazil



Pick Handle with Rubber Guard

Item Code	Length	INN	CTN
BRAG5004	35½"	6	6

- Made in Brazil



Heavy Duty Gravel Rake

Item Code	Description	INN	CTN
BRAG1012	14 TINE	1	1

- Made in Brazil



Heavy Duty Bow Rake

Item Code	Description	INN	CTN
BRAG1013	14 TINE	1	1

- Made in Brazil

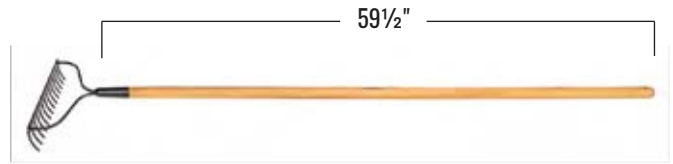

Heavy Duty Forged Hay Fork

Item Code	Description	INN	CTN
BRAG1015	4 TINE	6	6

- Made in Brazil

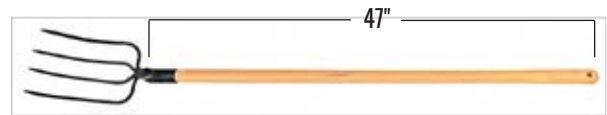

Garden Rake Handle

Item Code	Size	INN	CTN
BRAG5003	51"	12	12

- Conical tip: 5/8"
- Made in Brazil



Grave Rake Handle

Item Code	Size	INN	CTN
BRAG5008	57"	1	1

- Made in Brazil

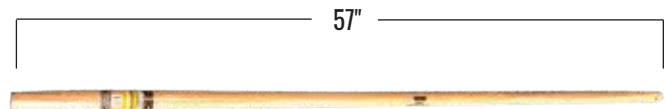

SHOVELS

British Style Shovel

Item Code	Size	INN	CTN
BR11255	48"	1	1

- Long hardwood handle for strength and durability
- Sharp blade makes it easy to dig in harder soils and materials

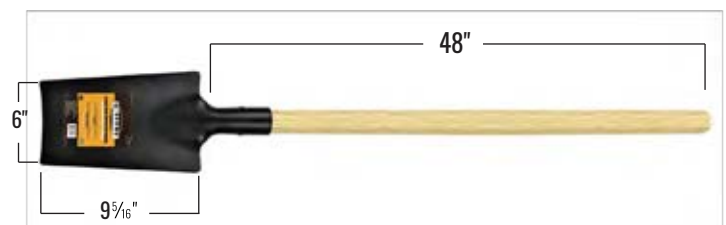

Round Shovel

Item Code	Size	INN	CTN
BRAG1004	48"	6	6

- Long hardwood handle for strength and durability
- Sharp blade makes it easy to dig in harder soils and materials
- Made in Brazil

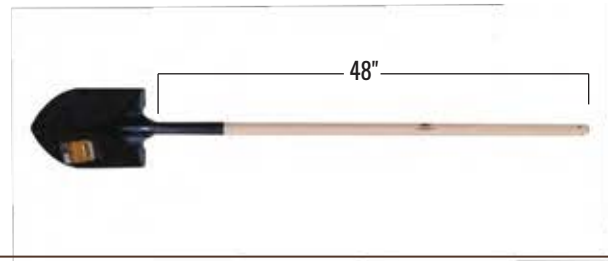

Square Shovels

Item Code	Size	INN	CTN
BRAG1005	31½"	6	6

- Long hardwood handle for strength and durability
- Power-D grip for comfort and control
- Made in Brazil

Item Code	Size	INN	CTN
BRAG1006	48"	6	6

- Long hardwood handle for strength and durability
- Sharp blade makes it easy to dig in harder soils and materials
- Made in Brazil



Spade Shovels

Item Code	Size	INN	CTN
BRAG1007	29"	6	6

- Hardwood handle for strength and durability
- Power-D grip for comfort and control
- Made in Brazil

Item Code	Size	INN	CTN
BRAG1008	48"	6	6

- Long hardwood handle for strength and durability
- Sharp blade makes it easy to dig in harder soils and materials
- Made in Brazil

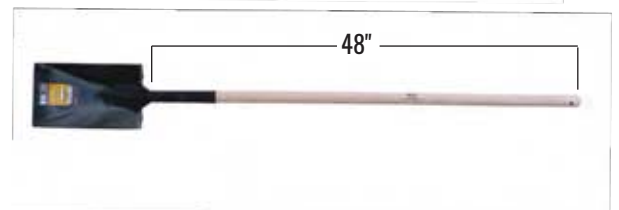
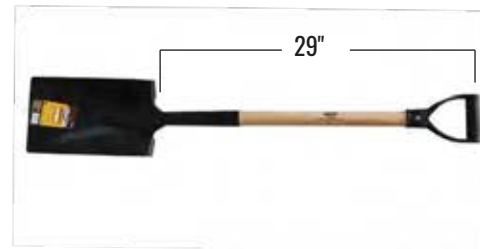

Shovel Handle

Item Code	Size	INN	CTN
BRAG5005	47"	1	1

- Made in Brazil

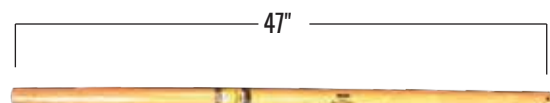

Power-D Shovel Handle

Item Code	Size	INN	CTN
BRAG5006	28"	1	1

- Power-D grip for comfort and control
- Made in Brazil



HOES

Round Eye Hoes

Item Code	Weight	INN	CTN
BRAG0001	2 lbs	1	1

- Made in India
- * Handle sold separately

Item Code	Weight	INN	CTN
BRAG0002	2 lbs	12	12

- Made in India
- * Handle sold separately



Sunken Eye Hoe

Item Code	Weight	INN	CTN
BRAG0003	3.75 lbs	12	12

- Made in India
- * Handle sold separately

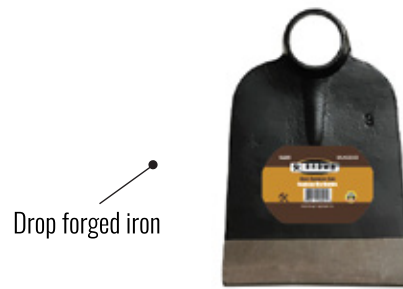

HOLE DIGGER

Hole Digger

Item Code	Size	INN	CTN
BRAG1009	47 1/2"	6	6

- Hole digger with rubber guard
- Made in Brazil

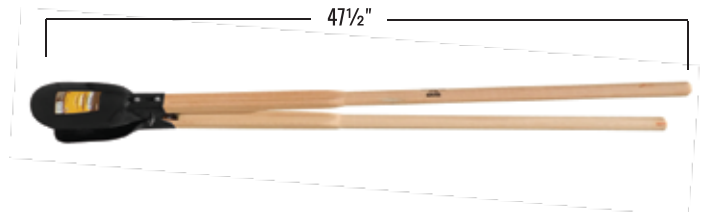

RAKES

Heavy Duty Gravel Rake

Item Code	Description	INN	CTN
BRAG1011	14 TINE	12	12

- * Handle sold separately

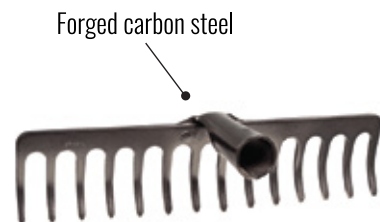

Plastic Rakes

Item Code	Description	INN	CTN
BRAG1020	22 TINE	10	10

* Handle sold separately

Item Code	Description	INN	CTN
BRAG1021	30 TINE	6	6

* Handle sold separately



Gravel Rake

Item Code	Description	INN	CTN
GR1500	14 TINE	1	24

* Handle sold separately

Forged carbon steel



Reinforced Rake

Item Code	Description	Material	INN	CTN
R11000	22 TINE	Metal	1	24



Fan Rake

Item Code	Description	Material	INN	CTN
R11022	22 TINE	Metal	1	24



MACHETES

Machetes with Plastic Handle

Item Code	Size	INN	CTN
BRAG2018	18"	12	60
BRAG2020	20"	12	60
BRAG2022	22"	12	60
BRAG2024	24"	12	60
BRAG2026	26"	12	60



- Made in Brazil

Machetes with Wood Handle

Item Code	Size	INN	CTN
BRAG2118	18"	6	36
BRAG2120	20"	6	36
BRAG2122	22"	6	36



- Made in Brazil

Item Code	Size	INN	CTN
BRAG2124	24"	6	36
BRAG2126	26"	6	36



- Made in Brazil

LUCHET

Luchet Scraper/Digger

Item Code	Size	INN	CTN
BRAG1016	12"	6	6

- Made of forged carbon steel
* Handle sold separately



Luchet Scraper/Digger with Handle

Item Code	Size	INN	CTN
BRAG1017	55"	6	6

- Made in Brazil



LAWN CARE

Agricultural Sprayers

Item Code	Capacity	INN	CTN	Item Code	Description	INN	CTN
BRTF05	5 liters	1	6	BRTF18	Spare Parts BRTF05-10	1	1
BRTF08	8 liters	1	6				

- General purpose agricultural sprayer for spraying in and around your garden
- Fully adjustable nozzle and trigger lock
- Ideal for spraying water, fertilizer, herbicides, pesticides, etc.
- Can also be used for spraying cleaning detergents or solvent-free preservative treatments

Item Code	Capacity	INN	CTN	Item Code	Description	INN	CTN
BRTF16	16 l	1	1	BRTF19	Spare Parts BRTF16	1	1

- General purpose agricultural sprayer for spraying in and around your garden
- Fully adjustable nozzle and trigger lock
- Ideal for spraying water, fertilizer, herbicides, pesticides, etc.
- Can also be used for spraying cleaning detergents or solvent-free preservative treatments



Fruit Picker

Item Code	Description	Size	INN	CTN
BRFPB004	Basket	13" x 5 3/4"	6	24
BRFPP001	Pole	5'-10'	6	24

- Perfect for harvesting hard to reach fruits
- Made of steel



Hedge Shears

Item Code	Size	INN	CTN
BRAG1022	12"	12	12

- Special heat treated Boron steel
- Made in Brazil
- Polished blades



Pruning Shears

Item Code	Size	INN	CTN
SE731SC	8"	6	36

- Heat treated
- Teflon coating reduces friction and resists rust
- Ratchet function



High carbon steel blade

Comfortable grip handles

Grass Trimmer Lines

Item Code	Size	Shape	INN	CTN
BRGTL0001	50' x 0.080"	Round	6	60
BRGTL0002	50' x 0.095"	Round	6	60
BRGTL0003	50' x 0.105"	Round	6	60
BRGTL0004	50' x 0.130"	Round	6	60
BRGTL0006	1 lb x 0.080"	Round	6	36
BRGTL0007	1 lb x 0.095"	Round	6	36
BRGTL0008	1 lb x 0.105"	Round	6	36
BRGTL0012	3 lbs x 0.095"	Round	1	12
BRGTL0013	3 lbs x 0.105"	Round	1	12
BRGTL3301	50' x 0.080"	Square	6	60
BRGTL3302	50' x 0.095"	Square	6	60
BRGTL3303	50' x 0.105"	Square	6	60
BRGTL3312	3 lbs x 0.095"	Square	1	12

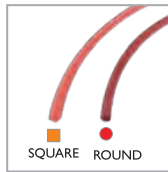

SQUARE ROUND



- Used for trimming and edging grass

IRRIGATION

PVC Garden Hoses

Item Code	Size	INN	CTN
BRGH12500	1/2" x 50'	10	10
BRGH12100	1/2" x 100'	5	5
BRGH58050	5/8" x 50'	5	5
BRGH58100	5/8" x 100'	3	3

- Tough weather-resistant cover
- Full-flow brass couplings

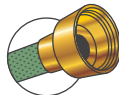

Brass coupling for secure connections

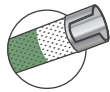

Radial braid reinforcement for durability



Solid Brass Hose Nozzles

Item Code	Size	INN	CTN
BRHS0300	3"	12	144
BRHS0400	4"	12	144

- Fits all garden hoses
- Rust-resistant



Adjustable spray:
from fine mist to
jet stream

Plastic Hose Nozzles

Item Code	Size	INN	CTN
BRHS0500	5½"	6	48

- On/off handle control

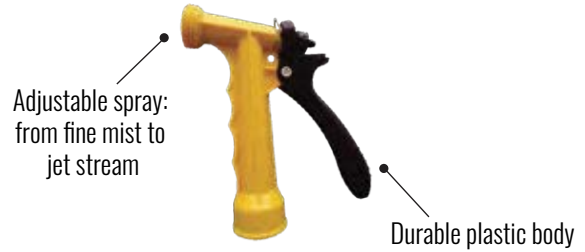

Adjustable spray:
from fine mist to
jet stream

Durable plastic body

Item Code	Size	INN	CTN
BRSG9515	6"	6	48

- On/off handle control



Adjustable spray:
from fine mist to
jet stream

Rubber handle
for better grip

Zinc Hose Nozzle

Item Code	Size	INN	CTN
BRSG9516	5½"	6	48



Adjustable spray:
from fine mist to
jet stream

Zinc alloy body

Rubber handle
for better grip

ABS Hose Couplings

Item Code	Size	Adapter	INN	CTN
BRGC120	½"	Female	10	100
BRGC130	½"	Male	10	100
BRGC140	½"	Mender	10	100

- Prolongs hose life



Non-corrosive

ABS Hose Couplings

Item Code	Size	Adapter	INN	CTN
BRGC502	5/8" - 3/4"	Female	10	100
BRGC503	5/8" - 3/4"	Male	10	100
BRGC504	5/8" - 3/4"	Mender	10	100

- Prolongs hose life



ABS Hose Couplings

Item Code	Size	Adapter	INN	CTN
BRHC012	1/2"	Female	10	100
BRHC013	1/2"	Male	10	100
BRHC014	1/2"	Mender	10	100

- Prolongs hose life

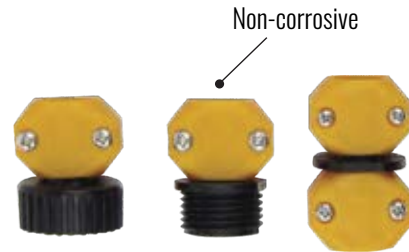

ABS Hose Couplings

Item Code	Size	Adapter	INN	CTN
BRHC016	5/8" - 3/4"	Female	10	100
BRHC017	5/8" - 3/4"	Male	10	100
BRHC018	5/8" - 3/4"	Mender	10	100

- Prolongs hose life



Hose Washer

Item Code	Size	QTY	INN	CTN
BRHW001	3/4"	10 Pack	30	120

- Durable
- Provides a tight seal and fixes leaks and drips



Hose Repairs

Item Code	Size	Adapter	INN	CTN
HC012	1/2" x 3/4"	Female	24	480
HC013	1/2" x 3/4"	Male	24	480
HC014	1/2"	Mender	12	240

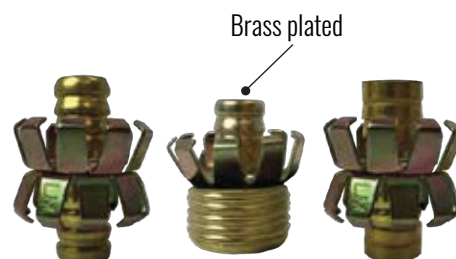

HOSE CLAMP

Hose Clamps

Item Code	Size	Finish	INN	CTN
60000	00-1/2"	Zinc Plated	500	2500
60001	0-3/4"	Zinc Plated	500	2500
60002	1A-1"	Zinc Plated	500	2500
60003	2A-1 1/2"	Zinc Plated	250	500
60004	2x-2"	Zinc Plated	250	500
60005	4A-3"	Zinc Plated	150	500

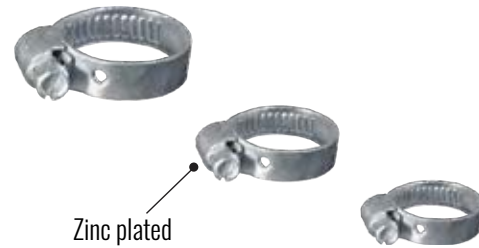

WHEELBARROWS

Wheelbarrows

Item Code	Length	Width	Height	Cubic Ft	Tray Thickness	INN	CTN
BRWB005	39"	25.25"	11"	6	21 Gauge	1	1
BRWB006	39"	25.25"	12.25"	7	20 Gauge	1	1

- Solid polyurethane tire



Flat-Free Tire

Item Code	Dimensions	INN	CTN
BRWB3505	15.5" x 8" x 3.6"	1	1



BOOTS



Leather Work Boots

Item Code	Color	EUR Size	US Size	CTN
BRWB12YL	Wheat	45	12	10
BRWB11YL	Wheat	44	11	10
BRWB10YL	Wheat	43	10	10
BRWB09YL	Wheat	42	9	10



Steel toe protects against impact and compression



Rubber outsole delivers slip resistance for optimal traction

Item Code	Color	EUR Size	US Size	CTN
BRWB12BK	Black	45	12	10
BRWB11BK	Black	44	11	10
BRWB10BK	Black	43	10	10
BRWB09BK	Black	42	9	10



Steel toe protects against impact and compression



Rubber outsole delivers slip resistance for optimal traction

- Offers protection against open circuits in dry conditions
- Additional support offered by a steel shank
- Dual density EASE footbed offers superior comfort
- Shock absorption offers maximum protection against chemical elements



Leather Work Boots

Item Code	Color	EUR Size	US Size	CTN
BRWB12TB	Brown	45	12	10
BRWB11TB	Brown	44	11	10
BRWB10TB	Brown	43	10	10
BRWB09TB	Brown	42	9	10



Puncture-resistant



Anti-slip outsole

Heel energy absorption for support from impact

- Resistant sole
- Comfort wear
- Anti-smashing cap

PVC Boots

Item Code	EUR Size	US Size	CTN
BRRWB080	41	8	10
BRRWB090	42	9	10
BRRWB100	43	10	10
BRRWB110	44	11	10
BRRWB120	45	12	10
BRRWB130	46	13	10
BRRWB140	47	14	10

- Anti-acid/alkali/oil
- Comfortable to wear
- Waterproof

Item Code	EUR Size	US Size	CTN
BRRWB009ST	42	9	10
BRRWB010ST	43	10	10
BRRWB011ST	44	11	10
BRRWB012ST	45	12	10

- Anti-acid/alkali/oil
- Steel plate
- Comfortable to wear
- Waterproof



Anti-slip outsole



Anti-slip outsole

Steel toe

WIRE MESHES

Welded Iron Wire Mesh

Item Code	Gauge	Opening	Pattern	Height	Length	CTN
BRMS3310	33	1/16" x 1/16"	Square	3'	100'	1

- Electrogalvanized after weaving
- Packaged in waterproof paper with plastic film around it
- Can be used for animal control, tree guards, screen doors, gutter guards, cages, craft projects, gardening, tunneling animals

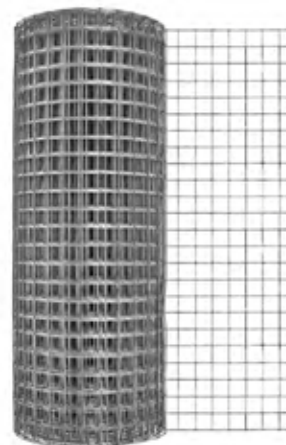

Welded Iron Wire Meshes

Item Code	Gauge	Opening	Pattern	Height	Length	CTN
BRMS1610	16	1/2" x 1/2"	Square	3'	100'	1
BRMS1620	16	3/4" x 3/4"	Square	3'	100'	1
BRMS1630	16	1/2" x 1/2"	Square	4'	100'	1
BRMS1640	16	3/4" x 3/4"	Square	4'	100'	1
BRMS1810	18	1/2" x 1/2"	Square	3'	100'	1
BRMS1820	18	3/4" x 3/4"	Square	3'	100'	1
BRMS1830	18	1/2" x 1/2"	Square	4'	100'	1
BRMS1840	18	3/4" x 3/4"	Square	4'	100'	1
BRMS1910	19	1/2" x 1/2"	Square	3'	100'	1
BRMS2310	23	1/4" x 1/4"	Square	3'	100'	1
BRMS2710	27	1/8" x 1/8"	Square	3'	100'	1

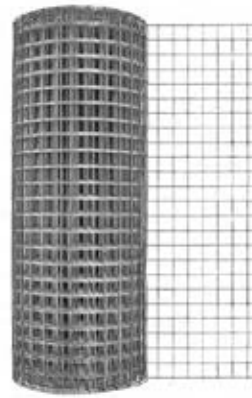

- Hot-dipped galvanized after welding
- Packaged in waterproof paper and plastic film around it
- Can be used for animal control, tree guards, screen doors, gutter guards, cages, craft projects, gardening, tunneling animals

Item Code	Gauge	Opening	Pattern	Height	Length	CTN
BRMS1920	19	1"	Hexagonal	4'	150'	1
BRMS2210	22	1/2"	Hexagonal	3'	150'	1
BRMS2220	22	1/2"	Hexagonal	4'	150'	1



- Hot-dipped after weaving
- Reverse twisted
- Packaged in waterproof paper and plastic film around it
- Can be used for animal control, tree guards, screen doors, gutter guards, cages, craft projects, gardening, tunneling animals

CLEAN WATER PUMP

Self-Priming Pumps + Pressure Tanks

Item Code	HP	Frequency	Tank Capacity	INN
BRWP100SET	1	60 Hz	80 l / 21 gal	1
BRWP100SET50-S	1	50 Hz	36 l / 9 gal	1
BRWP100SET-S	1	60 Hz	36 l / 9 gal	1
BRWP500SET	1/2	60 Hz	24 l / 6 gal	1
BRWP500SET50	1/2	50 Hz	24 l / 6 gal	1
BRWP750SET	3/4	60 Hz	36 l / 9 gal	1
BRWP750SET50-S	3/4	50 Hz	24 l / 6 gal	1
BRWP750SET-S	3/4	60 Hz	24 l / 6 gal	1

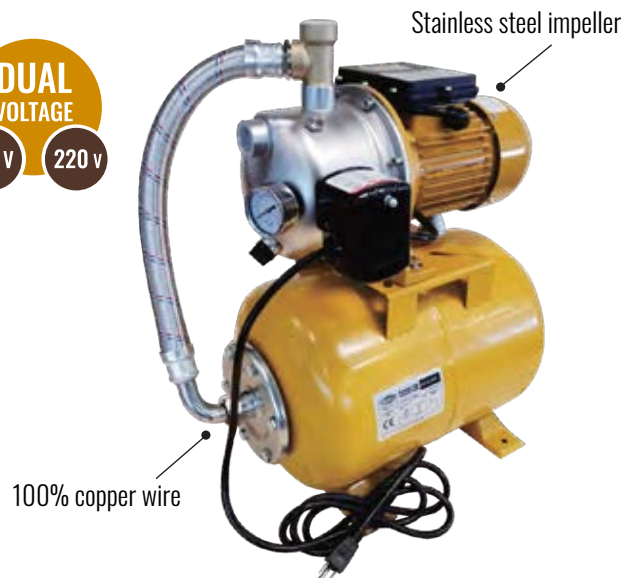
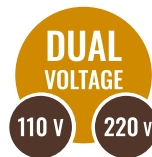

- For clean water and non-aggressive fluids
- Includes:
 - Brass tee
 - Thermal protector
 - 26" stainless steel hose
 - 1 pc 8' copper strong 3C cable with American plug
 - Pressure gauge

SPARE PARTS

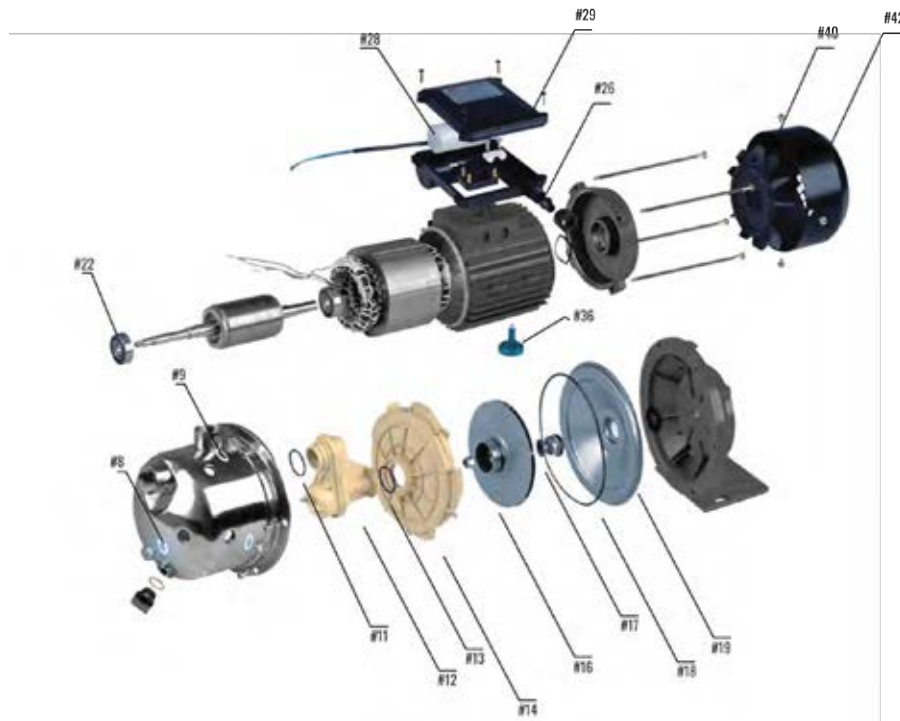

Picture	Item Code	Part Description	Available For:					
			BRWP100JSS BRWP100JSS50	BRWP500JSS BRWP500JSS50	BRWP750JSS BRWP750JSS50	BRWP100JCI	BRWP500JCI	BRWP750JCI
	BRWP100JSS001	Mechanical Seal	✓	✓	✓			
	BRWP100JCI001					✓	✓	✓
	BRWP100JSS002	O Ring	✓	✓	✓	✓	✓	✓
	BRWP100JSS004	O Ring For Gauge	✓	✓	✓	✓	✓	✓
	BRWP100JSS005	Fan	✓	✓	✓	✓	✓	✓
	BRWP100JSS006	Fan Cover	✓	✓	✓	✓	✓	✓
	BRWP100JSS007	Capacitor	✓			✓		
	BRWP500JSS007			✓			✓	
	BRWP750JSS007					✓		✓
	BRWP100JSS008	Terminal Boxes	✓	✓	✓	✓	✓	✓
	BRWP100JSS009	Bearing	✓	✓	✓	✓	✓	✓
	BRWP100JSS010	Diffuser	✓	✓	✓	✓	✓	✓
	BRWP100JSS011	Venturi Tube	✓			✓		
	BRWP500JSS011			✓			✓	
	BRWP750JSS011					✓		✓
	BRWP100JSS012	Foot	✓	✓	✓	✓	✓	✓
	BRWP100JSS016	304 Stainless Steel Impeller	✓					
	BRWP500JSS016			✓				
	BRWP750JSS016				✓			
	BRWP100JSS019	304 Stainless Steel Mechanical Seal Disc Holder	✓	✓	✓			
	BRWP100JCI019					✓	✓	✓



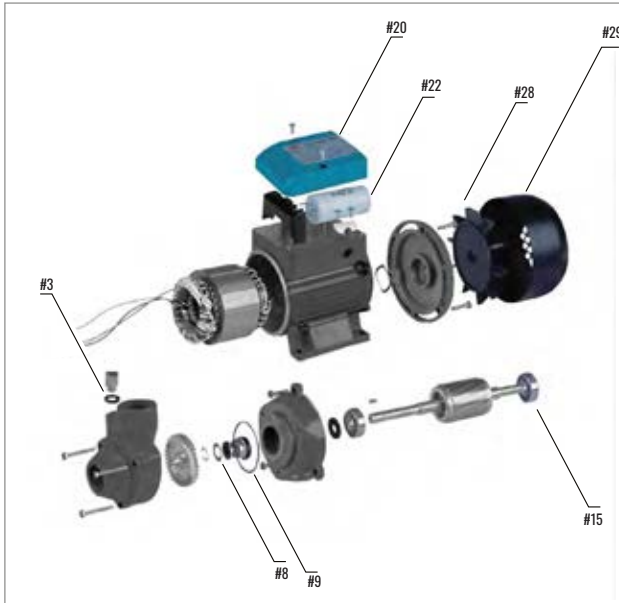

Picture	Item Code	Part Description
	BRWP050CW001	Mechanical Seal
	BRWP075CW001	Mechanical Seal
	BRWP050CW002	O Ring
	BRWP075CW002	O Ring
	BRWP050CW004	O Ring For Gauge
	BRWP075CW004	O Ring For Gauge
	BRWP050CW005	Fan
	BRWP075CW005	Fan
	BRWP050CW006	Fan Cover
	BRWP075CW006	Fan Cover
	BRWP050CW007	Capacitor
	BRWP075CW007	Capacitor
	BRWP050CW008	Terminal Box
	BRWP075CW008	Terminal Box
	BRWP050CW009	Bearing
	BRWP075CW009	Bearing

Water Pumps

Item Code	HP	Max Flow/Min	Weight	Frequency	Power	INN	CTN
BRWP050CW	1/2	41 l / 10 gal	12 lbs	60 Hz	5 A / 2.5 A	1	4
BRWP075CW	3/4	48 l / 12 gal	21 lbs	60 Hz	7.6 A / 3.8 A	1	2

- 100% copper wire
- Strong brass impeller
- Includes:
 - Thermal protector
 - 1 roll PTFE seal tape
 - 1 pc 8' copper 3C cable with American plug

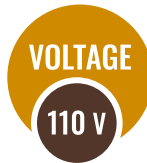

JET PUMPS

Self-Priming Jet Pumps

Item Code	HP	Max Flow/Min	Weight	Frequency	Power	INN	CTN
BRWP100JCI	1	50 l / 13 gal	30 lbs	60 Hz	10.4 A / 5.2 A	1	4
BRWP500JCI	1/2	42 l / 11 gal	27 lbs	60 Hz	6.4 A / 3.2 A	1	2
BRWP750JCI	3/4	46 l / 12 gal	28.8 lbs	60 Hz	8.4 A / 4.2 A	1	2

- Cast iron head
- 100% copper wire
- Includes:
 - Thermal protector
 - 1 roll PTFE seal tape
 - 1 pc 8' copper 3C cable with American plug

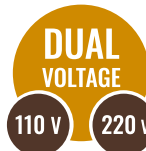

Stainless steel impeller



Self-Priming Jet Pumps

Item Code	HP	Max Flow/Min	Weight	Frequency	CTN
BRWP100JSS50	1	52 l / 13 gal	25.8 lbs	50 Hz	1
BRWP500JSS50	1/2	43 l / 11 gal	22 lbs	50 Hz	1
BRWP750JSS50	3/4	46 l / 12 gal	24 lbs	50 Hz	1

- Includes:
- Thermal protector
- 1 roll PTFE seal tape
- 1 pc 8' copper 3C cable with American plug

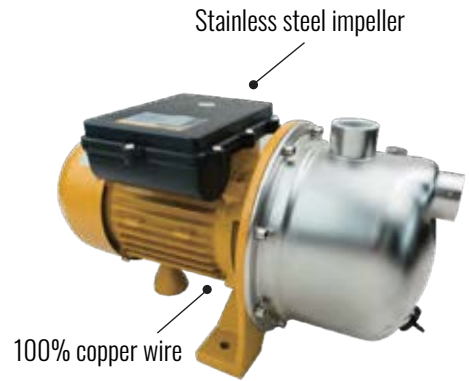
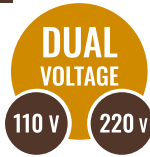

Item Code	HP	Max Flow/Min	Weight	Frequency	CTN
BRWP100JSS	1	52 l / 13 gal	25.8 lbs	60 Hz	1
BRWP500JSS	1/2	43 l / 11 gal	22 lbs	60 Hz	1
BRWP750JSS	3/4	46 l / 12 gal	24 lbs	60 Hz	1

- Includes:
- Thermal protector
- 1 roll PTFE seal tape
- 1 pc 8' copper 3C cable with American plug

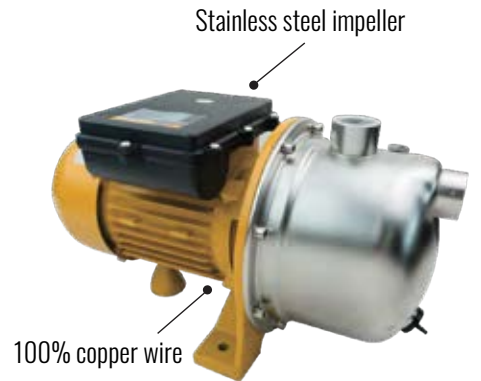
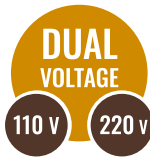

Hose For Water Pump

Item Code	Size	INN	CTN
BRP003H	26"	1	50



Water Pump Pressure Switches

Item Code	Connector	INN	CTN
WPS9013	Female	1	50
WPS9069	Male	1	50



SMART HEADS

Automatic Pump Controls

Item Code	Voltage	Frequency	INN	CTN
BRWP1300SH	110	60 Hz	1	12

Item Code	Voltage	Frequency	INN	CTN
BRWP1400SH	220	60 Hz	1	12
BRWP1400SH50	220	50 Hz	1	12



Item Code	Description
BRWP1300SH015	Rubber Membrane Replacement
BRWP1300SH022	Circuit Board Replacement



Brass Tee Fitting For Water Pump

Item Code	Length	INN	CTN
BRP004T	90 mm	1	100

- Brass construction
- For hot or cold water lines
- Swivel screw means no drilling or extra valves needed
- Maximum operating pressure: 2100 kPa

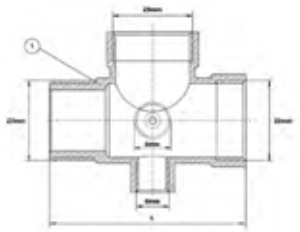

GAUGES

Gauges For Water Pumps

Item Code	Mounting	INN	CTN
BRP002B	Bottom Mount	1	200

Item Code	Mounting	INN	CTN
BRP002G	Back Mount	1	200



PRESSURE TANKS



Horizontal Pressure Tank

Item Code	Capacity	INN	CTN
BRP0001	6 gal	1	1

- Changeable EPDM membrane and flange
- Carbon steel body
- Working temperature: -10°C to 99°C
- Max pressure: 8 bar
- Connector: G1

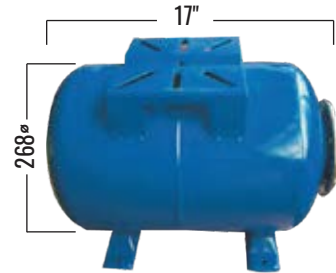

Vertical Pressure Tank

Item Code	Capacity	INN	CTN
BRP0002	5 gal	1	1

- Connector: G1



Vertical Pressure Tank

Item Code	Capacity	INN	CTN
BRP0003	10 gal	1	1
BRP0004	20 gal	1	1

- Connector: G1



Oil Pump

Item Code	Material	Type	CTN
ROP3000	Aluminium Alloy	Rotary	6



- Pump diameter: 5"
- Tube diameter: 1 1/4"
- Tube length: 40"
- Lift: 5 m
- Suction: 1 m
- Flow: 22 l

- Includes:
- 1 pump body
- 1 pipe outlet
- 1 handle
- 1 stator

* Pipe inlet packed separately



BACK SUPPORT

Back Support Belts

Item Code	Size	INN	CTN
BRDF031L	Large	1	24
BRDF031M	Medium	1	24
BRDF031XL	Extra Large	1	24

- Breathable mesh
- Black

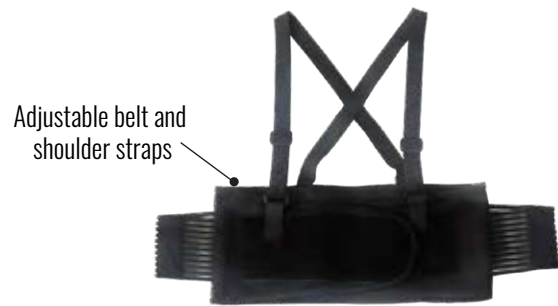

CAUTION TAPE

Caution Tape

Item Code	Width	Length	INN	CTN
BRCT072	2"	60 yds	1	48



Danger Tape

Item Code	Width	Length	INN	CTN
BRCT074	2"	110 yds	1	48

- For blocking off physical hazards or work areas



FACE PROTECTION

Dust Mask

Item Code	PCS/Box	INN	CTN
DM108	20	1	10

- N95-particulate filter (95% filtration efficiency)
- Effective against particulate free of oil
- FFP2NR
- EN 149:2001+AI:2009
- CE 2834



Single Cartridge Respirator

Item Code	Material	INN	CTN
BRR305	PVC	1	50

- Reusable
- Allows the use of protective eyewear
- Filtration efficiency is 95% for dust, mist, metallic fumes, spray paint, chemicals, and small flying particles of low toxicity
- Durable rubber face piece



Double Cartridge Respirator

Item Code	Material	INN	CTN
BRR306	PVC	1	50

- Reusable
- Allows the use of protective eyewear
- Filtration efficiency is 95% for dust, mist, metallic fumes, spray paint, chemicals, and small flying particles of low toxicity
- Durable rubber face piece



Respirator Cartridges

Item Code	INN	CTN
BRR201	1	60

- Replacement cartridges for BRR305 and BRR306
- Filtration efficiency is 95% for dust, mist, metallic fumes, spray paint, chemicals, and small flying particles of low toxicity



Safety Glasses

Item Code	Color	INN	CTN
G0621	Yellow	12	144
G0622	Clear	12	144
G0623	Dark Grey	12	144

- Impact and scratch resistant
- Meets ANSI Z87.1 standards



Premium Safety Glasses

Item Code	Description	INN	CTN
GOG24	Lightweight	12	144

- UV protection
- Meets ANSI Z87.1 standards

Impact and scratch-resistant



Replacement Tinted Welder's Glass

Item Code	Size	Glass	INN	CTN
BRDIN10	4.25" x 2"	#10	80	400
BRDIN11	4.25" x 2"	#11	80	400

- Industrial grade



Welder's Clear Glass

Item Code	Size	Glass	INN	CTN
BRDIN13	4.25" x 2"	#10	80	400

- Industrial grade



Welding Helmet

Item Code	INN	CTN
WH2000	15	30

Adjustable ratchet headband to custom fit your head



Heavy Duty Ratchet Tie-Down Straps

Item Code	Size	Capacity	INN	CTN
TTD001	2" x 27'	8,800 lbs	1	6
TTD002	4" x 27'	15,000 lbs	1	4

- Quick automatic release
- Heat treated hooks adjust to desired tension



GLOVES

Leather Work Gloves

Item Code	Size	INN	CTN
BRLWG002	10.5"	12	72

- Made of cowhide leather
- Knuckle strap provides extra protection



Leather Double Palm Work Gloves

Item Code	Size	INN	CTN
BRLWG007	10.5"	12	72

- For construction and heavy duty applications
- Split leather



Suede Welding Gloves

Item Code	Size	INN	CTN
GLOVE 004	14"	12	72

- Made of cowhide leather



Heavy Duty Industrial Latex Gloves

Item Code	Size	INN	CTN
GLOVE 010	18"	12	48

- Petrochemical and microorganism resistant
- Black exterior and orange interior



RAIN PROTECTION

Yellow Rain Coats

Item Code	Size	INN	CTN
BRRJ000	Small	1	20
BRRJ001	Medium	1	20
BRRJ002	Large	1	20
BRRJ003	Extra Large	1	20
BRRJ004	Extra Large	1	20

- Zipper and snap buttons



Two Piece Rain Suits

Item Code	Size	INN	CTN
BRRS200	Small	1	20
BRRS201	Medium	1	20
BRRS202	Large	1	20
BRRS203	Extra Large	1	20
BRRS204	Extra Large	1	20

- Includes jacket and pants
- Zipper and snap buttons



SAFETY EQUIPMENT

Safety Helmets

Item Code	Color	INN	CTN
SH1000	White	1	40
SH2000	Yellow	1	40
SH3000	Blue	1	40
SH4000	Orange	1	40

Color options:



- Self-sizing pinlock suspension
- Hard hat





Reflective Safety Straps

Item Code	Color	INN	CTN
BRSV002GXL	Green	1	100
BRSV002RXL	Red	1	100



- One size fits all

Adjustable shoulder and waist straps



100% Polyester

Safety clip

SIZE	M	L	XL
Body Length	25"	26.5"	27"
Shoulder Width	5"	5"	6"
Side Length	11.5"	12"	12.5"

Reflective Safety Vests

Item Code	Size	Color	INN	CTN
BRSV004GL	Large	Green	1	100
BRSV004GM	Medium	Green	1	100
BRSV004GXL	Extra Large	Green	1	100
BRSV004RL	Large	Red	1	100
BRSV004RM	Medium	Red	1	100
BRSV004RXL	Extra Large	Red	1	100



Breathable polyester



100% Polyester

Maximum visibility strips

Reflective Safety Vests

Item Code	Size	INN	CTN
BRLH005	Large	1	100

Breathable polyester



100% Polyester

Maximum visibility strips

Reflective Safety Vest

Item Code	Size	INN	CTN
BRLH009	Large	1	100

Breathable polyester



Maximum visibility strips

100% Polyester

Reflective Safety Vests

Item Code	Size	Color	INN	CTN
BRSV006GL	Large	Green	1	100
BRSV006GM	Medium	Green	1	100
BRSV006GXL	Extra Large	Green	1	100

NEW PRODUCT

With zipper and pockets



100% Polyester

Reflective Safety Vest

Item Code	Size	Color	INN	CTN
BRSV007RL	Large	Red	1	100

NEW PRODUCT

Breathable polyester



Maximum visibility strips

100% Polyester

PVC Traffic Cones

Item Code	Size	INN	CTN
BRTC18	18"	10	10
BRTC28	28"	10	10

Reflective tape



- Impact-resistant
- Made of virgin PVC

Galvanized Razor Spikes

Item Code	Size	INN	CTN
CBT76	6'	30	30
CBT77	6'	30	30

- Double row of barbed wall spikes
- Easy to install
- Maintenance-free

Galvanized
against corrosion



Razor Wires

Item Code	Diameter	Loops	Material	INN	CTN
CBT65	16"	33	Galvanized Steel	1	1
CBT65430	16"	33	Stainless Steel	1	1

- Without clips
- Durable and water-resistant
- For outdoor use
- Covers up to 26 feet



Screen Fiber Meshes

Item Code	Size	Color	Mesh	INN	CTN
BRSM0036	36" x 100'	Grey	18 x 16	1	4
BRSM0048	48" x 100'	Grey	18 x 16	1	4

- Designed to withstand all climates

Provides air ventilation
and insect protection

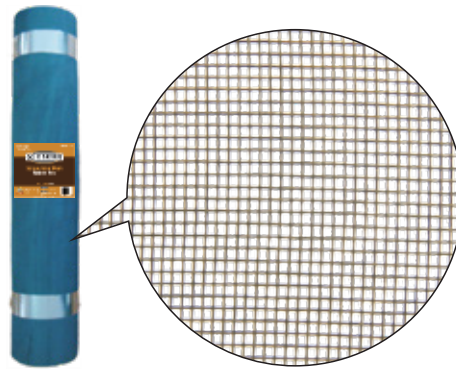

Screen Fiber Meshes

Item Code	Size	Color	Mesh	INN	CTN
BRSM3600	36" x 100'	Charcoal	18 x 16	1	4
BRSM4800	48" x 100'	Charcoal	18 x 16	1	4

- Designed to withstand all climates

Provides air ventilation
and insect protection

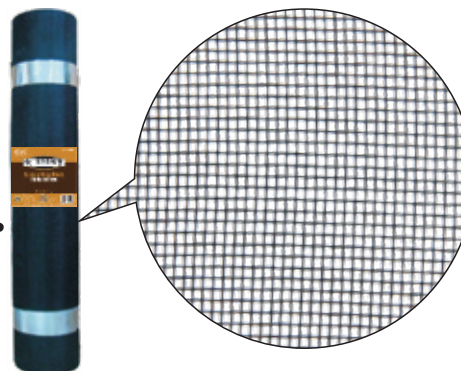

ROOF PATCH

Roof Patch

Item Code	Size	INN	CTN
BRPS004	4" x 33.5'	6	6

- Flashing tape
- Self-adhesive
- Waterproof
- For roofing and exterior walls

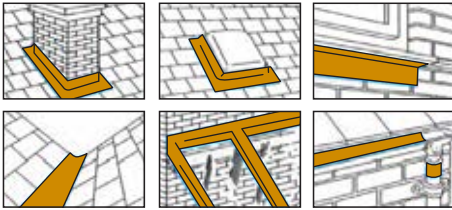

TARPS

Poly Tarps

Item Code	Size	Thickness	INN	CTN
PET0068	6' x 8'	5 mil	25	25
PET0810	8' x 10'	5 mil	20	20
PET1012	10' x 12'	5 mil	20	20
PET1214	12' x 14'	5 mil	10	10
PET1216	12' x 16'	5 mil	10	10
PET1220	12' x 20'	5 mil	5	5
PET1225	12' x 25'	5 mil	5	5
PET1416	14' x 16'	5 mil	5	5
PET1418	14' x 18'	5 mil	5	5
PET1620	16' x 20'	5 mil	5	5
PET1820	18' x 20'	5 mil	5	5
PET1824	18' x 24'	5 mil	5	5
PET2020	20' x 20'	5 mil	5	5

Item Code	Size	Thickness	INN	CTN
PET2024	20' x 24'	5 mil	4	4
PET2030	20' x 30'	5 mil	4	4
PET2040	20' x 40'	5 mil	3	3
PET2430	24' x 30'	5 mil	3	3
PET2436	24' x 36'	5 mil	3	3
PET2440	24' x 40'	5 mil	2	2
PET2555	25' x 55'	5 mil	2	2
PET3040	30' x 40'	5 mil	2	2
PET3050	30' x 50'	5 mil	1	1
PET3460	34' x 60'	5 mil	1	1
PET4040	40' x 40'	5 mil	1	1
PET4060	40' x 60'	5 mil	1	1
PET50100	50' x 100'	5 mil	1	1

- Mesh count: 10 x 8
- GSM 90
- Durable
- Waterproof
- Reusable
- Grommets every 3 ft





Superior Poly Tarps

Item Code	Size	Thickness	INN	CTN
ST0068S	6' x 8'	10 mil	25	25
ST0810S	8' x 10'	10 mil	10	10
ST1012S	10' x 12'	10 mil	10	10
ST1216S	12' x 16'	10 mil	5	5
ST1620S	16' x 20'	10 mil	5	5
ST1820S	18' x 20'	10 mil	5	5
ST1824S	18' x 24'	10 mil	5	5
ST2020S	20' x 20'	10 mil	2	2
ST2030S	20' x 30'	10 mil	2	2
ST2430S	24' x 30'	10 mil	2	2
ST3040S	30' x 40'	10 mil	1	1
ST3050S	30' x 50'	10 mil	1	1



- Mesh count: 14 x 14
- GSM 180
- Durable
- Waterproof
- Reusable
- Grommets every 3 ft
- 2x as strong as standard blue tarps

Heavy Duty PVC Tarps

Item Code	Size	Thickness	INN	CTN
HTT0810	8' x 10'	22 mil	5	5
HTT1012	10' x 12'	22 mil	3	3
HTT1214	12' x 14'	22 mil	2	2
HTT1418	14' x 18'	22 mil	1	1
HTT1620	16' x 20'	22 mil	1	1
HTT1820	18' x 20'	22 mil	1	1
HTT2024	20' x 24'	22 mil	1	1
HTT2030	20' x 30'	22 mil	1	1
HTT2430	24' x 30'	22 mil	1	1
HTT2436	24' x 36'	22 mil	1	1
HTT3040	30' x 40'	22 mil	1	1



GREAT FOR TRUCKS

- Mesh count: 9 x 9
- GSM 750
- Reinforced molded corners
- Waterproof
- Heat sealed seams
- Grommets every 2 ft
- Tear resistant





bisman[®]
WATER'S CHOICE

HOSE BIBBS

Brass Hose Bibbs

Item Code	Size	Weight	INN	CTN
BMA2401234BL	1/2" x 3/4"	275 g	6	72
BMA2401234	1/2" x 3/4"	275 g	6	60
BMA2403434	3/4" x 3/4"	290 g	6	60

- Heavy duty type
- NPT thread
- 1/2" inlet, 3/4" outlet
- Replaceable gasket



Rough Brass Hose Bibb

Item Code	Size	Weight	INN	CTN
BMA3101234	3/4" x 1/2"	230 g	6	60

- Brass stem
- NPT thread
- Replaceable gasket
- Extra thread

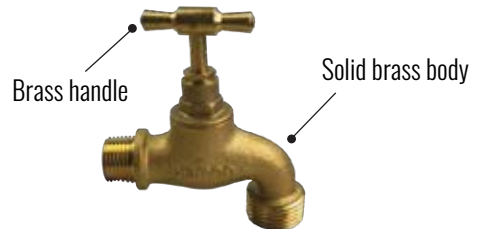

Brass Hose Bibbs

Item Code	Size	Weight	INN	CTN
BM1351234	1/2" x 3/4"	140 g	6	60

Item Code	Size	Weight	Packaging	INN	CTN
BM1351234BL	1/2" x 3/4"	140 g	Double Blister	6	60

- Brass stem
- NPT thread
- Replaceable gasket
- Extra thread

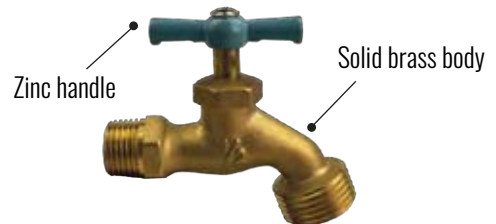

Rough Brass Locking Hose Bibb

Item Code	Size	Weight	INN	CTN
BMA3251234	1/2" x 3/4"	250 g	6	60

- Lock type
- Chrome plated
- NPT thread

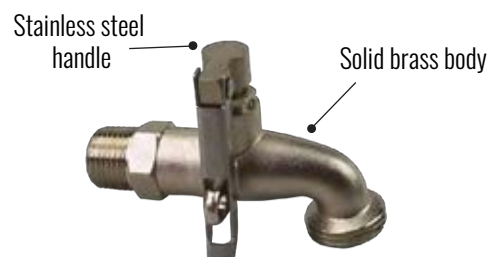

Brass Hose Bibb

Item Code	Size	Weight	INN	CTN
BMA3351234	1/2" x 3/4"	220 g	6	60

- Brass stem
- NPT thread
- Replaceable gasket
- Extra thread

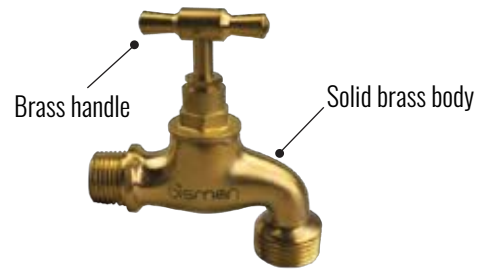

Rough Brass Stop Valve

Item Code	Size	INN	CTN
BMA2461212	1/2" x 1/2"	6	60

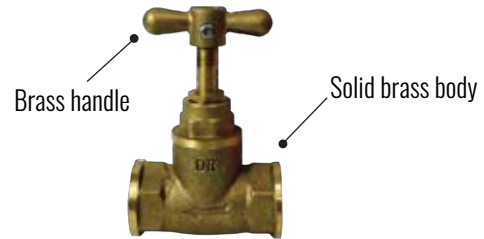

PVC Hose Bibbs

Item Code	Size	INN	CTN
BMCB1234	1/2" x 3/4"	12	48
BMCB3434	3/4" x 3/4"	12	48

- Use with hot or cold water up to 180° F
- Use thread seal tape or compound when installing
- Do not use with compressed air



BRASS VALVES

Brass Angle Valves

Item Code	FIP Inlet	COMP Outlet	INN	CTN
BMA3010	1/2"	3/8"	20	200

- American standard size
- Celcon stem

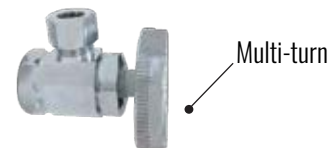

Item Code	FIP Inlet	COMP Outlet	INN	CTN
BMA3011B	1/2"	3/8"	20	200

- American standard size
- Brass stem



Brass Straight Angle Valve

Item Code	FIP Inlet	COMP Outlet	INN	CTN
BMA3065	1/2"	3/8"	20	200

- American standard size
- Celcon stem

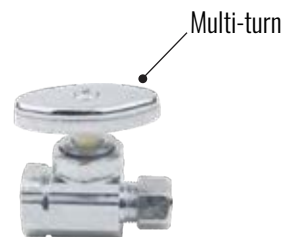

Brass Angle Valves

Item Code	FIP Inlet	COMP Outlet	INN	CTN
BMA3060	1/2"	3/8"	10	200

- American standard size
- Celcon stem



Item Code	FIP Inlet	IPS Outlet	INN	CTN
BMAM3401	1/2"	1/2"	20	200

- American standard size
- Celcon stem

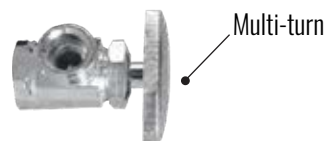

Ball Valves

Item Code	Size	INN	CTN
BMBV0012	1/2"	12	120
BMBV0034	3/4"	10	100
BMBV0100	1"	6	60

- For water, oil, and gas
- Max pressure: 600 PSI for water, oil, gas, and 150 PSI for steam



Solid brass construction

Threaded Gate Valves

Item Code	NPT	INN	CTN
BMGV001	1/2"	6	48
BMGV002	3/4"	6	48
BMGV003	1"	6	48

- Max pressure: 200 PSI
- For water, oil, and gas

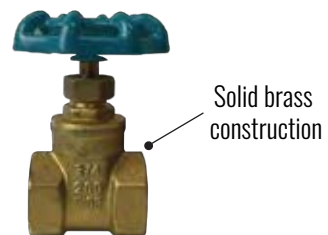

Spring Check Valves

Item Code	NPT	INN	CTN
BMSCV0012	1/2"	6	96
BMSCV0034	3/4"	6	72
BMSCV0100	1"	6	48



- Stainless steel spring
- Max pressure: 200 PSI

Urinal Valve

Item Code	Finish	CTN
BMUV001	Chrome Plated	24

- Works with all standard urinals



PVC FITTINGS

PVC Ball Valves

Item Code	Size	CTN
BM880120	1/2"	195
BM880340	3/4"	120
BM880100	1"	83
BM880125	1 1/4"	56
BM880150	1 1/2"	36
BM880200	2"	25
BM880300	3"	12

Slip x Slip
Type



- Meets schedule 40 standards
- Max pressure: 200 PSI

PVC Check Valves

Item Code	Size	CTN
BM910012	½"	120
BM910034	¾"	120
BM910100	1"	64
BM910150	1½"	42

Slip x Slip
Type

- Meets schedule 40 standards



PVC Compression Valves

Item Code	Size	CTN
BM950012	½"	160
BM950034	¾"	100
BM950100	1"	100
BM950150	1½"	50
BM950200	2"	25
BM950300	3"	12
BM950400	4"	6

- For use in any general piping applications
- Used with metal, plastic, or copper pipes
- Convenient to use and easy to operate for instant piping
- Meets schedule 40 standards



PVC Unions

Item Code	Size	CTN
BM550100	1"	126
BM550120	½"	320
BM550125	1¼"	64
BM550150	1½"	48
BM550200	2"	32
BM550340	¾"	196

Slip x Slip
Type

- Meets schedule 40 standards
- Max pressure: 200 PSI





WASTE DRAINS

Faucet Hole Covers

Item Code	Size	INN	CTN
BMFHC0175	1 3/4"	24	240
BMFHC0200	2"	24	240



PVC Tailpiece

Item Code	Size	INN	CTN
BMP0114	1 1/4" x 5 1/2"	1	100

- With sink drain stopper
- Includes an overflow plug



PVC P-Trap with Adaptor

Item Code	Adaptor Size	CTN
BMNA003	1 1/2"	50



- Includes:
 - 1 J-bend piece
 - 1 P-bend piece
 - 3 nuts
 - 2 slip washers
 - 1 1 1/2" to 1 1/4" reducing washer piece
 - 1 adaptor



PVC Sink Drain Tailpieces

Item Code	Inlet	Length	INN	CTN
BMNA112	1 1/2"	6"	12	120
BMNA114	1 1/4"	6"	12	120

- Includes slip joint nut
- Extends waste connection from sink
- One piece construction



PVC Slip Joint Center Outlet Waste

Item Code	Inlet	Length	CTN
BMNA116	1½"	16"	120



- With baffle tee
- Center outlet continuous waste
- Includes:
 - 3 nuts
 - 2 washers



PVC S-Trap Sink Drain

Item Code	Inlet	Length	CTN
BMNA117	1½"	20½"	40



- Includes:
 - 3 nuts
 - 2 washers



P-Trap Connectors

Item Code	Size	Angle	INN	CTN
BMPTW001	4"	Straight	1	48
BMPTW002	4"	20 Degree	1	48
BMPTW003	4"	90 Degree	1	25

- PP body
- PVC black seal ring



Adjustable P-Trap Connector

Item Code	Diameter	Length	INN	CTN
BMPTW004	4"	22"	1	20

- PE body
- Reinforced with steel wire and TPE seal ring
- J-bend



Tip-Toe Push Bath Connector

Item Code	Size	INN	CTN
BMBD76	1½"	1	20

- Includes all necessary tubes and fittings for installation
- Fits regular tubs
- Includes overflow protection



Square Floor Drains

Item Code	Size	Material	CTN
BMFD44	4" x 4"	Stainless Steel	14
BMFD66	6" x 6"	Stainless Steel	10



Shower Drains with Grid

Item Code	Size	INN	CTN
BMSD0112	1½"	12	120
BMSD0200	2"	12	120

- Stainless steel grid



Sink Strainer

Item Code	Size	Material	INN	CTN
BMSD0300	4"	Plastic	6	48

- ABS chrome plated



Sink Strainer

Item Code	Size	Material	INN	CTN
BMSD0400	4"	Stainless Steel	6	48

- Includes basket and plug



Basket Strainer

Item Code	Size	Material	INN	CTN
BMSD0500	3.5"	Stainless Steel	6	60



Laundry Tub Strainer Basket

Item Code	Size	Material	INN	CTN
BMSD0600	1½"	Stainless Steel	10	100



With rubber drain stopper



Laundry Tub Strainer Basket

Item Code	Size	Material	INN	CTN
BMSD0700	1½"	Plastic	10	200

With rubber drain stopper



Brass Bath Waste Slotted

Item Code	Size	INN	CTN
BMBW1430	1¼" x 3"	6	60

- Solid brass structure
- With rubber drain stopper



Brass Bath Waste Unslotted

Item Code	Size	INN	CTN
BMBW1515	1½" x 1½"	6	60
BMBW1520	1½" x 2"	6	60
BMBW1530	1½" x 3"	6	60

- Solid brass structure
- With rubber drain stopper



Unslotted Bath Waste

Item Code	Size	INN	CTN
BMBW1431	1¼" x 3"	6	60

- Solid brass structure



Bath Waste Drain with Chain

Item Code	Size	Description	INN	CTN
BMPBW1431	1 1/4" x 3 1/4"	Unslotted	12	96
BMPBW1515	1 1/2" x 2"	Unslotted	12	96
BMPBW1530	1 1/2" x 3 1/4"	Unslotted	12	96



Brass Pop-Up Drain

Item Code	Size	Material	CTN
BMPP001	1 1/4" x 8"	Stainless Steel	30



- Outlet tube: 4" x 20 gauge
- Includes:
 - Stopper linkage
 - Upper rods
 - Lower rods



Pop-Up Drains

Item Code	Size	Finish	INN	CTN
BMPP007	1 1/4" x 8"	Brass	1	50
BMPP008	1 1/4" x 8 1/2"	Plastic	1	70



TAPE

PTFE Thread Sealing Tapes

Item Code	Size	INN	CTN
BMPTFE01	1/2" x 33'	10	1000
BMPTFE03	1/2" x 33'	10	1000
BMPTFE04	3/4" x 33'	10	1000
BMPTFE05	3/4" x 16'	10	1000



- Provides a strong tight seal for any threaded joint
- Plumber's tape

KITCHEN FAUCETS

Single Handle Kitchen Faucet

Item Code	CTN
BMKF001SS	12



- Ceramic cartridge
- Flow rate: 1.5 GPM



Deck plate available on page 138

Single Handle Kitchen Faucet

Item Code	CTN
BMKF002SS	12



Dual Function Sprayer

Spray mode	Stream mode

- Ceramic cartridge
- Flow rate: 1.5 GPM



Deck plate available on page 138

Single Handle Kitchen Faucet

Item Code	CTN
BMKF003SS	12



Dual Function Sprayer

Spray mode	Stream mode

- Ceramic cartridge
- Flow rate: 1.5 GPM



Deck plate available on page 138

Single Handle Kitchen Faucet

Item Code	CTN
BMKF004SS	12



Dual Function Sprayer

Spray mode	Stream mode

- Ceramic cartridge
- Flow rate: 1.5 GPM



Deck plate available on page 138

Single Handle Kitchen Faucet

Item Code	CTN
BMKF005SS	12



Dual Function Sprayer

Spray mode	Stream mode

- Ceramic cartridge
- Flow rate: 1.5 GPM



Deck plate available on page 138

Single Handle Kitchen Faucet

Item Code	CTN
BMKF006SS	12



Dual Function Sprayer

Spray mode Stream mode



- Ceramic cartridge
- Flow rate: 1.5 GPM

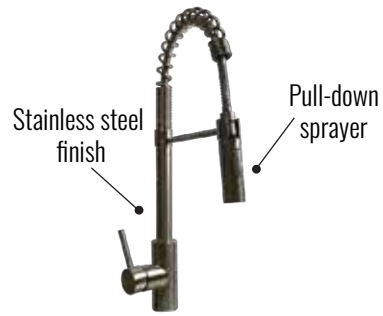

Deck plate available on page 138

Single Handle Kitchen Faucet

Item Code	Centerset	CTN
BMKF001CP	8"	6



- Flow rate: 2.2 GPM at 60 PSI



Dual Handle Kitchen Faucet

Item Code	Centerset	CTN
BMKF002CP	8"	6



- Flow rate: 2.2 GPM at 60 PSI

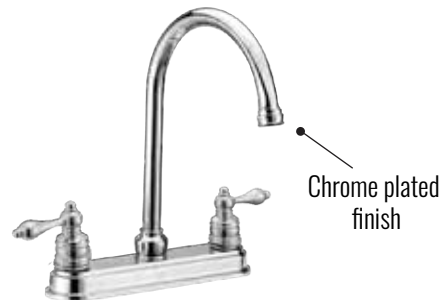

Single Handle Kitchen Faucet

Item Code	CTN
BMKF003CP	6

- Flow rate: 2.2 GPM at 60 PSI



Single Handle Kitchen Faucet

Item Code	CTN
BMKF004CP	6



- Ceramic cartridge
- 59" hose
- Aerator saves and softens water
- Flow rate: 2.2 GPM at 60 PSI



Single Handle Kitchen Faucet

Item Code	CTN
BMKF005CP	6

- 24" water supply hose included
- Flow rate: 1.5 GPM



Single Handle Kitchen Faucet

Item Code	CTN
BMKF006CP	6

- 24" water supply hose included
- Flow rate: 1.5 GPM



Star Handle Kitchen Faucet

Item Code	INN	CTN
BM4511	1	24



Star Handle Kitchen Faucet

Item Code	CTN
BM3511	12

- Ceramic stem
- Flow rate: 2.5 GPM at 60 PSI



Dual Handle Kitchen Faucet

Item Code	Centerset	INN	CTN
BMA0471	8"	1	12

- Sayco compatible
- Flow rate: 2.2 GPM at 60 PSI

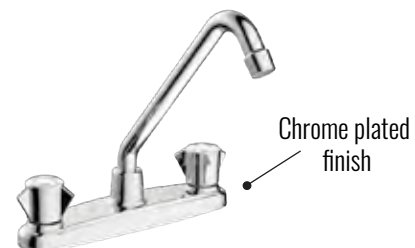

Single Handle Kitchen Faucet

Item Code	Centerset	CTN
BMKF001NM	8"	12

- Ceramic cartridge
- Flow rate: 1.5 GPM



Dual Handle Kitchen Faucet

Item Code	Centerset	CTN
BMKF002NM	8"	12

- Ceramic cartridge
- Flow rate: 1.5 GPM

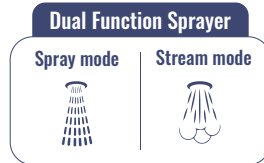

Dual Handle Kitchen Faucet

Item Code	Centerset	CTN
BMKF003NM	8"	12

- Ceramic cartridge
- Flow rate: 1.5 GPM

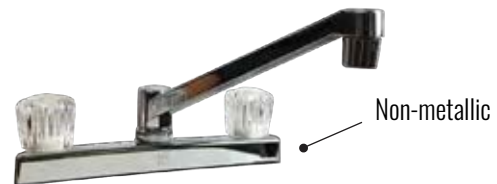

Dual Handle Kitchen Faucet

Item Code	Centerset	CTN
BMKF004NM	8"	12

- Ceramic cartridge
- Flow rate: 1.5 GPM



Dual Handle Kitchen Faucet

Item Code	Centerset	CTN
BMKF005NM	8"	12

- Ceramic cartridge
- Flow rate: 1.5 GPM



Single Handle Faucet

Item Code	Inlet	INN	CTN
BM4511T	1/2"	1	24

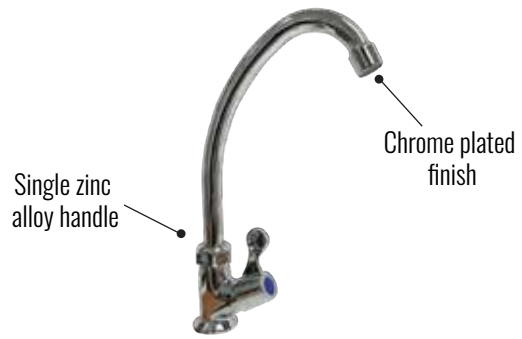

Single Handle Faucet

Item Code	Inlet	CTN
BMA2113	1/2"	30



LAVATORY FAUCETS

Single Handle Lavatory Faucet

Item Code	CTN
BMLF001SS	12

- Flow rate: 1.2 GPM



Deck plate available on page 138

Single Handle Lavatory Faucet

Item Code	CTN
BMLF002SS	12

- Flow rate: 1.2 GPM



Deck plate available on page 138

Single Handle Lavatory Faucet

Item Code	CTN
BMLF003SS	12

- Flow rate: 1.2 GPM



Deck plate available on page 138

Single Handle Lavatory Faucet

Item Code	CTN
BMLF004SS	12

- Flow rate: 1.2 GPM



Stainless steel finish

Deck plate available on page 138

Single Handle Lavatory Faucet

Item Code	Centerset	CTN
BMLF001CP	4"	6

- Flow rate: 2.0 GPM at 60 PSI



Chrome plated finish

Dual Handle Lavatory Faucet

Item Code	Centerset	CTN
BMLF002CP	4"	6

- Flow rate: 2.0 GPM at 60 PSI



Chrome plated finish

Dual Handle Lavatory Faucet

Item Code	Centerset	CTN
BMLF003CP	4"	6

- Flow rate: 2.0 GPM at 60 PSI



Chrome plated finish

Single Handle Lavatory Faucet

Item Code	CTN
BMLF004CP	6

- Flow rate: 1.5 GPM



Chrome plated finish

Dual Handle Faucet

Item Code	Centerset	INN	CTN
BMA0481	4"	1	12

- Compression cartridge
- Brass waterway
- Sayco compatible
- Flow rate: 2.0 GPM at 60 PSI



Single Handle Lavatory Faucet

Item Code	Centerset	CTN
BMLF001NM	4"	12

- Ceramic cartridge
- Flow rate: 1.2 GPM



Dual Handle Lavatory Faucet

Item Code	Centerset	CTN
BMLF002NM	4"	12

- Ceramic cartridge
- Flow rate: 1.2 GPM



Dual Handle Lavatory Faucet

Item Code	Centerset	CTN
BMLF003NM	4"	12

- Ceramic cartridge
- Flow rate: 1.2 GPM



Single Handle Lavatory Faucet

Item Code	Centerset	CTN
BMLF004NM	4"	12

- Ceramic cartridge
- Flow rate: 1.2 GPM



Dual Handle Lavatory Faucet

Item Code	Centerset	CTN
BMLF005NM	4"	12

- Ceramic cartridge
- Flow rate: 1.2 GPM



Dual Handle Lavatory Faucet

Item Code	Centerset	CTN
BMLF006NM	4"	12

- Ceramic cartridge
- Flow rate: 1.2 GPM



Dual Handle Lavatory Faucet

Item Code	Centerset	CTN
BMLF007NM	4"	12

- Ceramic cartridge
- Flow rate: 1.2 GPM



Dual Handle Bar Faucet

Item Code	Centerset	INN	CTN
BMPL0006	4"	1	24

- Compression valve



Dual Handle Laundry Tub Faucet

Item Code	Centerset	CTN
BMPL0007	4"	24

- Compression valve



Star Handle Basin Tap

Item Code	Inlet	INN	CTN
BM4115	½"	1	40

- Polished chrome finish

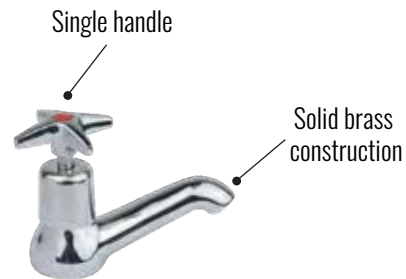

Single Handle Basin Tap

Item Code	Inlet	INN	CTN
BM4115T	½"	1	40

- Polished chrome finish

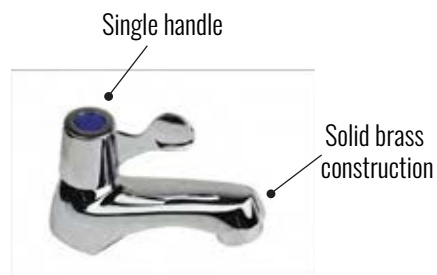

Single Handle Basin Faucet

Item Code	Inlet	INN	CTN
BMA3004	½"	1	50

- Polished chrome finish



SHOWER FAUCETS

Tub & Shower Faucet

Item Code	CTN
BMBSF001CP	6

- Single metal handle
- Flow rate: 2.5 GPM at 80 PSI



Tub & Shower Faucet

Item Code	CTN
BMBSF002CP	6

- Triple metal handle
- Flow rate: 2.5 GPM at 80 PSI

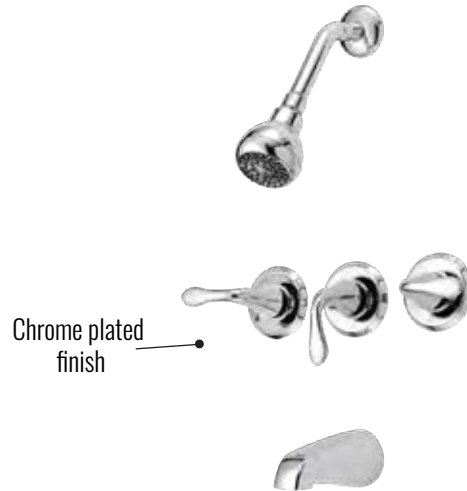

Tub & Shower Faucet

Item Code	CTN
BMBSF003CP	6

- Single metal handle
- Flow rate: 2.5 GPM at 80 PSI

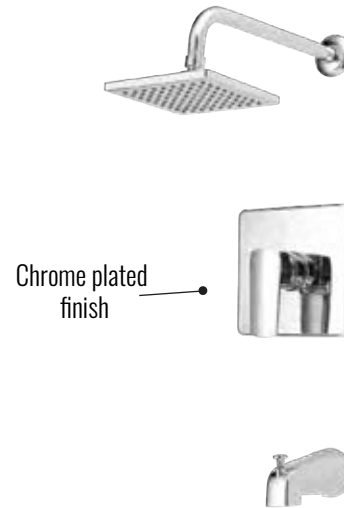

Tub & Shower Faucet

Item Code	CTN
BMA0491	8

- Double handle
- Brass spout diverter
- Compression cartridge
- Flow rate: 2.5 GPM at 80 PSI



3-Valve Shower Set

Item Code	INN	CTN
BMA0494	1	8



- Compression valve
- Flow rate: 2.5 GPM at 80 PSI



Shower Head Set

Item Code	Size	CTN
BMHSS7006	6"	24



- 360° swivel design
- Flow rate: 2.5 GPM at 80 PSI

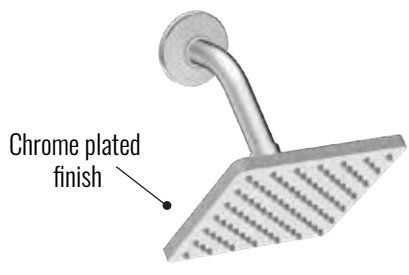

Shower Head Set

Item Code	CTN
BMHSS7004	24



3 Available Functions



- 360° swivel design
- Conserves water
- Flow rate: 2.5 GPM at 80 PSI



Shower Head

Item Code	Size	INN	CTN
BMA7004M	3¾"	1	50

3 Available Functions



- Conserves water
- Flow rate: 2.5 GPM at 80 PSI

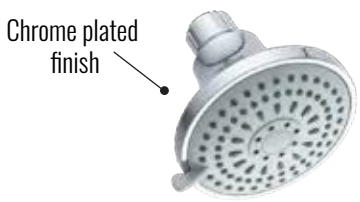

Shower Head Set

Item Code	Head Size	INN	CTN
BMHSS0001	3½"	6	48

- Three layer chrome for maximum rust resistance
- 360° swivel design



Shower Head Set

Item Code	Head Size	INN	CTN
BMHSS0002	2"	6	48

- 360° swivel design
- Three layer chrome for maximum rust resistance



5-Function Shower Set

Item Code	CTN
BMHSS0005	20

- 360° swivel design
- Flow rate: 2.5 GPM at 80 PSI



Shower Head

Item Code	Description	CTN
BMA6021	Shower Head & Flange	120
BMA6022	Shower Arm Flange	500
BMA6023	Shower Arm	200
BMA6024	Shower Head	120

- ABS



Shower Set

Item Code	CTN
BMA7001	10

- Max water pressure: 85 PSI
- 24" stainless steel sliding bar
- ABS

3 Available Functions

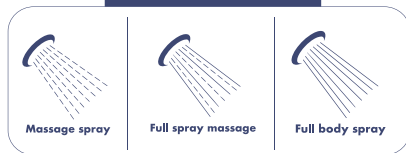

chrome plated finish

Single Shower Valve

Item Code	Size	CTN
BMA0490	1/2"	30

- Compression cartridge
- Brass waterway



Metal handle

chrome plated finish

Single Shower Valve

Item Code	Size	CTN
BMA7010	1/2"	48

- 1/4" turn valve



Metal handle

Chrome plated finish

Shower Valve Handle

Item Code	Description	INN	CTN
BMA0494HR	Handle With Red Ring	6	120

- Brass body
- For BMA0490, BMA0491, and BMA0494



Brass handle

Shower Valve Stems

Item Code	Steam Type	INN	CTN
BMA0494C	Cold Water	12	180
BMA0494H	Hot Water	12	180



NPT Brass Nipple

Item Code	Size	INN	CTN
BMNB1230	1/2" x 3"	12	120



Chrome plated finish

Shower Hose

Item Code	Size	INN	CTN
BMSH0015	59"	1	50

- Flow rate: 6.5 GPM



Stainless steel finish

INSTALLATION

Deck Plate For Lavatory Faucet

Item Code	Size	CTN
BMSSDP401	4"	60



Stainless steel finish

Deck Plate For Kitchen Faucet

Item Code	Size	CTN
BMSSDP801	8"	60



Stainless steel finish

BASINS

Wall Mounted Basin

Item Code	Size	Centerset	INN	CTN
BS2000A	19" x 17"	4"	1	1

- With overflow protection



A GRADE



Round Drop-In Basin

Item Code	Size	Centerset	Shape	INN	CTN
BS3000A	19"	4"	Round	1	1

- With overflow protection

A GRADE



Oval Drop-In Basin

Item Code	Size	Centerset	Shape	INN	CTN
C207A	19" x 17"	4"	Oval	1	1

- With overflow protection

A GRADE



Undermount Basin

Item Code	Size	CTN
UC207A	19¼" x 16¼"	1

- With overflow protection

A GRADE



Lavatory Basin

Item Code	Size	INN	CTN
AS401	19" x 17"	1	1

- With overflow protection



TOILETS

Round Front Toilet

Item Code	Width	Height	Depth	Chair Height	CTN
AS2001AA	16½"	29"	26¾"	15"	1

- 1.6 GPF
- 2 piece
- S-trap
- Toilet seat included
- Single flush
- UPC fittings included



Elongated Front Toilet

Item Code	Width	Height	Depth	Chair Height	CTN
ETS601A	16½"	29"	28"	15"	1

- 1.6 GPF
- 2 piece
- S-trap
- Toilet seat included
- Single flush
- UPC fittings included



Comfort Height Elongated Toilet

Item Code	Width	Height	Depth	Chair Height	CTN
AS1006A	16½"	31"	28¾"	17¼"	1

- 1.6 GPF
- 2 piece
- S-trap
- Toilet seat included
- Single flush
- UPC fittings included



Round Front Toilet

Item Code	Width	Height	Depth	Chair Height	CTN
ASPT4003S	15¾"	29¾"	25"	15"	1



- 1.6 GPF
- 2 piece
- P-trap
- Toilet seat included
- Single flush
- UPC fittings included



Comfort Height Elongated Toilet

Item Code	Width	Height	Depth	Chair Height	CTN
AS1003A	14"	29¾"	30"	16½"	1

- 1.6 GPF
- 1 piece
- S-trap
- Comfort height
- Single flush
- Slow close seat
- Includes:
UPC fittings
Wax ring
Anchor bolts
Nuts



Round Plastic Toilet Seat

Item Code	Color	INN	CTN
TS100	White	10	10

- Installation hardware included

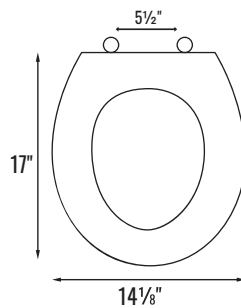

Round Plastic Toilet Seat

Item Code	Color	INN	CTN
DLA035	White	10	10

- Installation hardware included

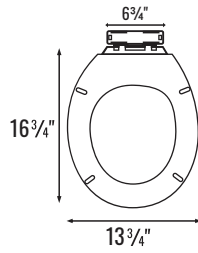

Elongated Plastic Toilet Seat

Item Code	Color	INN	CTN
ETS1000	White	10	10

- Installation hardware included

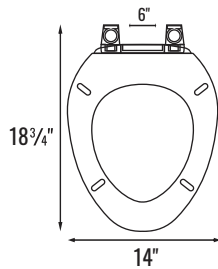

Slow Close Elongated Toilet Seat

Item Code	Color	INN	CTN
SCETS1000	White	10	10

- Installation hardware included
- Color-matched nylon hinges

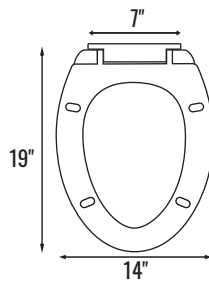

MDF Wood Round Toilet Seat

Item Code	Color	INN	CTN
BTS0000	White	10	10

- Enameled wood
- Installation hardware included
- Fits standard round bowls

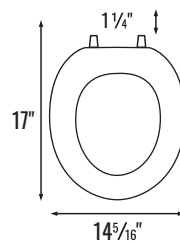

Slow Close Round Toilet Seat

Item Code	Color	INN	CTN
SCETS2000	White	10	10

- Installation hardware included
- Color-matched nylon hinges

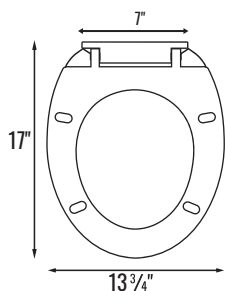

URINALS

Wall Hung Urinal

Item Code	Size	CTN
E268	21" x 13 1/4" x 7"	1

- 1.6 GPF
- Washout flush
- Backwall geometry
- Bottom strainer included



Flush valve available on page 118

Wall Hung Urinal

Item Code	Size	CTN
E268W	16 1/2" x 13 1/4" x 24"	1



- 1.6 GPF
- Washout flush
- Backwall geometry



Flush valve available on page 118

PEDESTAL

White Pedestal Basin

Item Code	Size	CTN
D178A	22" x 18" x 33½"	1

- Faucet not included



A GRADE



With overflow protection

SINGLE FLUSH



2 PIECE

S-TRAP



BATHROOM ACCESSORIES

Complete the look

CHROME PLATED FINISH

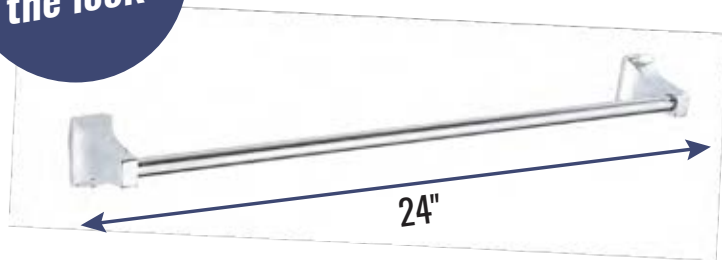

Item Code: BMBA001
Material: Zinc Alloy



Item Code: BMBA002
Material: Zinc Alloy

- Towel Bar
- Towel Ring
- Toilet Paper Holder

- Mounting hardware included
- INN 6 / CTN 24



Item Code: BMBA003
Material: Zinc Alloy



Complete the look

BRUSHED NICKEL FINISH

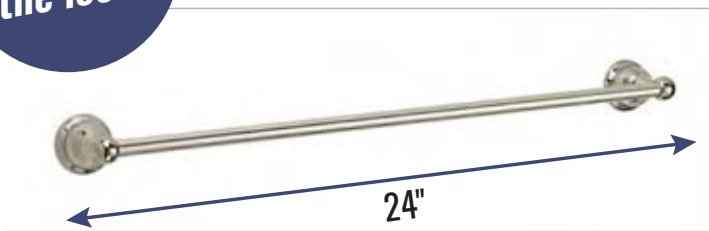

Item Code: BMBA007
Material: Zinc + Aluminum



Item Code: BMBA008
Material: Zinc + Aluminum

- Towel Bar
- Towel Ring
- Toilet Paper Holder

- Mounting hardware included
- INN 6 / CTN 24



Item Code: BMBA009
Material: Zinc + Aluminum



Complete the look

POLISHED CHROME FINISH

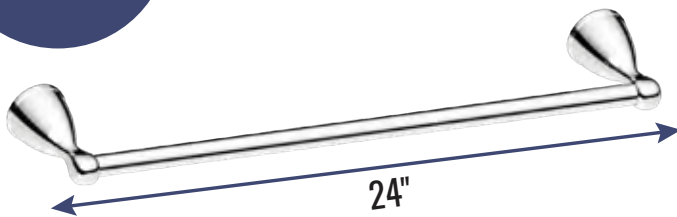

Item Code: BMBA004
Material: Zinc + SS



Item Code: BMBA005
Material: Zinc + SS



Item Code: BMBA006
Material: Zinc + ABS



- Towel Bar
- Towel Ring
- Toilet Paper Holder

- Mounting hardware included
- INN 6 / CTN 24

SPARE PARTS

Tank to Bowl Bolts

Item Code	Size	Material	INN	CTN
BM005805	5/16" x 3 1/8"	Solid Brass	50	200



Oval Closet Bolts

Item Code	Size	INN	CTN
BM007000	1/4" x 2 1/4"	20	200

- With anti-loosening nuts



Bowl to Floor Bolts

Item Code	Size	INN	CTN
BM007001	1/4" x 3"	50	400



Tank Lever

Item Code	Material	INN	CTN
BMA4044	Plastic	20	200



Tank Lever

Item Code	Description	INN	CTN
BMA4045	Metal Handle	20	20
BMA4045MN	Metal Handle with Metal Nut	20	20



Rubber Flappers with Chain

Item Code	Package	INN	CTN
BM2070	Boxed	6	60
BM2070BL	Blister Pack	6	60

- For S-trap toilets



Plastic Toilet Float

Item Code	Size	INN	CTN
BM2080	4" x 5"	1	60

- For use with all toilets
- Includes rust-resistant nut



Flush Valve

Item Code	Size	INN	CTN
BM3060	8" x 2"	1	50



Complete Toilet Fittings Set

Item Code	PCS	INN	CTN
BM3040	8	6	24

- For S-trap toilets



White Toilet Bolt Caps

Item Code	INN	CTN
BMTBC001	50	200

- Universal screw cap
- Covers exposed toilet bolts



Tank to Bowl Gasket

Item Code	Size	INN	CTN
BMSPG001	3 1/4"	50	200

- Fits most standard toilets



Wax Rings

Item Code	Description	INN	CTN
BMWRO01	Without Flange	1	80
BMWRO02	With Flange	1	40

- For floor outlet toilet bowls
- Fits 3' and 4' waste lines



HOSES

Braided PVC Supply Hoses

Item Code	Size	Length	INN	CTN
BMH002	3/8" COMP x 1/2" FIP PVC	16"	20	120
BMH003	3/8" COMP x 1/2" FIP PVC	20"	20	120

- For lavatory



Item Code	Size	Length	INN	CTN
BMH004	1/2" FIP x 1/2" FIP	20"	20	120
BMH007	3/8" COMP x 1/8" Ballcock	12"	20	120
BMH008	3/8" COMP x 1/8" Ballcock	16"	20	120
BMH009	3/8" COMP x 1/8" Ballcock	20"	20	120

- For water closet

Stainless Steel Supply Hoses

Item Code	Size	Length	INN	CTN
BMH221	3/8" COMP x 1/8" Ballcock	16"	20	120
BMH222	3/8" COMP x 1/2" FIP	16"	20	120
BMH223	3/8" COMP x 1/2" FIP	20"	20	120
BMH224	1/2" FIP x 1/2" FIP	16"	20	120
BMH225	1/2" FIP x 1/2" FIP	20"	20	120

- For lavatory



Y Hose Connectors

Item Code	Size	INN	CTN
BMFL64231	3/4"	12	60

- Plastic valve
- American standard screw thread



Item Code	Size	INN	CTN
BMFL8021	3/4"	12	60

- Die cast zinc
- American standard screw thread



Adjustable Anti-Siphon Fill Valve

Item Code	Size	INN	CTN
BM2045	8" - 12"	1	30



- Adjustable to fit most tanks
- Includes a locknut to prevent thread damage from overtightening
- Made of virgin ABS



Ballcock

Item Code	Size	INN	CTN
BM2050	8"	1	50



- Fits most tanks
- High pressure ball valve
- High quality plastic
- Brass screws



HAND TOOLS

Deluxe Plunger

Item Code	Size	INN	CTN
BMP006	6"	8	48

- With tailpiece
- For toilets



DOUBLE BOWLS

Kitchen Sinks with Drain Board

Item Code	Length	Width	Gauge	Depth	Finish	INN	CTN
BM15050L6	59"	19¾"	24	6"	Stainless Steel	1	5
BM15050L8	59"	19¾"	24	8"	Stainless Steel	1	5
BM15050R6	59"	19¾"	24	6"	Stainless Steel	1	5
BM15050R8	59"	19¾"	24	8"	Stainless Steel	1	5

- Satin finish
- Mounting clips included
- Scratch-resistant and sound-deadening
- Strainer sold separately



Double Bowl Kitchen Sink

Item Code	Length	Width	Gauge	Depth	Hole Size	Finish	INN	CTN
BM33196	33"	19"	22	6"	5/8"	Stainless Steel	1	5

- Satin finish
- Mounting clips included
- Scratch-resistant and sound-deadening
- Strainer sold separately



Double Bowl Kitchen Sinks

Item Code	Length	Width	Gauge	Depth	Hole Size	Finish	INN	CTN
BM33226	33"	22"	24	6"	5/8"	Stainless Steel	1	5
BM33228	33"	22"	22	8"	7/8"	Stainless Steel	1	5

- Satin finish
- Mounting clips included
- Scratch-resistant and sound-deadening
- Strainer sold separately



SINGLE BOWLS

Single Bowl Kitchen Sinks

Item Code	Length	Width	Gauge	Depth	Finish	INN	CTN
BM10050L	39½"	19¾"	24	6"	Stainless Steel	1	5
BM10050R	39½"	19¾"	24	6"	Stainless Steel	1	5

- Satin finish
- Mounting clips included
- Scratch-resistant and sound-deadening
- Strainer sold separately



Single Bowl Bar Sink

Item Code	Length	Width	Gauge	Depth	Finish	INN	CTN
BM15156	15"	15"	24	5½"	Stainless Steel	1	5

- Satin finish
- Mounting clips included
- Scratch-resistant and sound-deadening
- Strainer sold separately



Single Bowl Sinks

Item Code	Length	Width	Gauge	Depth	Hole Size	Finish	INN	CTN
BM25228	25"	22"	22	8"	⅞"	Stainless Steel	1	5
BM25226	25"	22"	24	6"	⅝"	Stainless Steel	1	5

- Satin finish
- Mounting clips included
- Scratch-resistant and sound-deadening
- Strainer sold separately



Undermount Sink

Item Code	Length	Width	Gauge	Depth	Finish	INN	CTN
BMUS301	23"	17¾"	18	9"	Stainless Steel	1	5

- Satin finish
- Mounting clips included
- Scratch-resistant and sound-deadening
- Strainer sold separately



Undermount Double Bowl Sink

Item Code	Length	Width	Gauge	Depth	Finish	INN	CTN
BMUE208	31¼"	18"	20	9"	Stainless Steel	1	5

- Satin finish
- Mounting clips included
- Scratch-resistant and sound-deadening
- Strainer sold separately



Undermount Offset Sinks

Item Code	Length	Width	Gauge	Depth	Finish	INN	CTN
BMU0907	31¼"	20½"	18	9" - 8"	Stainless Steel	1	5
BMU0907R	31¼"	20½"	18	8" - 9"	Stainless Steel	1	5

- Satin finish
- Mounting clips included
- Scratch-resistant and sound-deadening
- Strainer sold separately



Undermount Sink

Item Code	Length	Width	Depth	Gauge	Finish	INN	CTN
BMUS401	30"	18"	9"	18	Stainless Steel	1	5

- Satin finish
- Mounting clips included
- Scratch-resistant and sound-deadening
- Strainer sold separately



Undermount Sink

Item Code	Length	Width	Gauge	Depth	Finish	INN	CTN
BMUS307	23¼"	21"	18	9"	Stainless Steel	1	5

- Satin finish
- Mounting clips included
- Scratch-resistant and sound-deadening
- Strainer sold separately



LAUNDRY TUBS

Double Bowl Laundry Tub

Item Code	Height	Width	Depth	INN	CTN
BRLB102000	34"	40"	24"	1	1

- Virgin plastic
- Mustee brand
- With metal legs



Laundry Tub With Scrub

Item Code	Height	Width	Depth	CTN
BRLB2118	12"	18"	21"	9

- Wall mount
- Made of heavy duty plastic
- Stain-resistant
- For indoor and outdoor use
- Adjustable height during installation



Plastic Laundry Basin

Item Code	Width	Length	Depth	CTN
BRLB2223	22¾"	23"	12½"	1

- Virgin plastic
- With metal legs



Plastic Laundry Basin

Item Code	Width	Length	Depth	CTN
BRLB2325	23"	25"	13"	1

- Virgin plastic
- Mustee brand
- Made in USA
- With metal legs



PURIFIED FILTERS

Water Filter Housing

Item Code	Size	Casing	CTN
BMWF001	10"	Blue	25
BMWF002	10"	Clear	25

- Minimum working pressure: 70 PSI
- Maximum working pressure: 110 PSI
- Maximum working temperature: 40°C



Activated Carbon Water Filter

Item Code	Size	CTN
BMWF3001	10"	25

- Water pressure: 0.1 MPa - 0.4 MPa
- Water temperature: 4°C - 38°C
- Water resource: tap water
- CTO-10
- Function: Removal of organic chemicals, pesticides, floating substances, chlorine, odors, bad tastes, colors, and heavy metal particles that contaminate drinking water



HEAVY DUTY HOUSING



PRESSURE RELIEF BUTTON



Carbon Block Water Filter



Item Code	Size	CTN
BMWF3002	10"	25

- Water pressure: 0.1 MPa - 0.4 MPa
- Water temperature: 4°C - 38°C
- Water resource: tap water
- UDF-10A
- Function: Removal of organic chemicals, pesticides, floating substances, chlorine, odors, bad tastes, colors, and heavy metal particles that contaminate drinking water

Polypropylene Fiber Filter



Item Code	Size	CTN
BMWF3003	10"	25

- Filtration precision: 5 micron
- Water pressure: 0.1 MPa - 0.4 MPa
- Water temperature: 4°C - 38°C
- Water resource: tap water
- 1 micron PP
- Function: Removal of dust, rust, and large impurities that contaminate drinking water and increase its turbidity

Household Replacement Filter



Item Code	Size	CTN
BMWF3004	10"	25

- Filtration precision: 5 micron
- Water pressure: 0.1 MPa - 0.4 MPa
- Water temperature: 4°C - 38°C
- Water resource: tap water
- 5 micron PP
- Function: Removal of dust, rust, and large impurities that contaminate drinking water and increase its turbidity

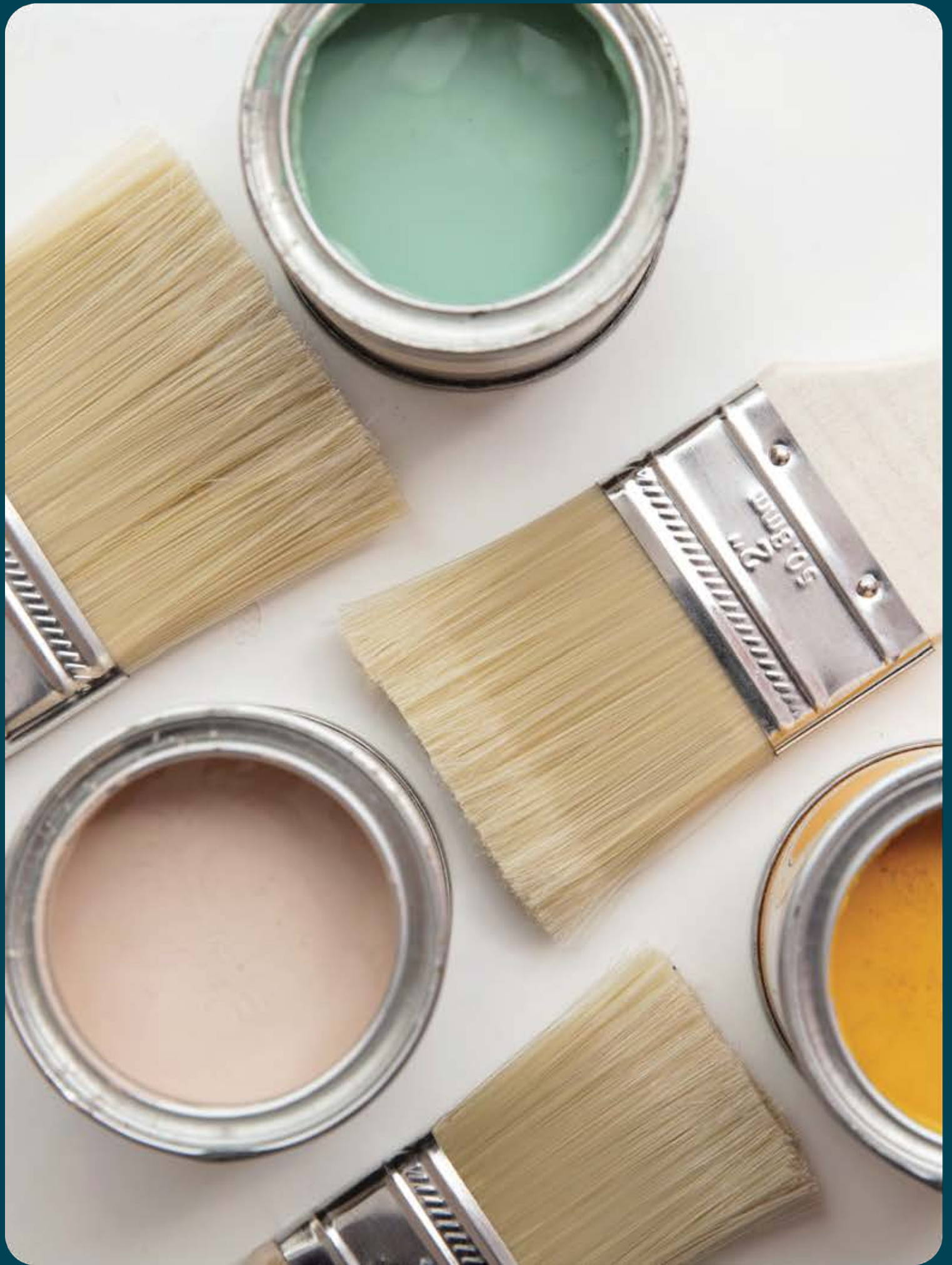



Premium Paint Brush

Item Code	Size	Bristle Length	INN	CTN
LNA1001	½"	1¾"	12	600
LNA1002	¾"	1¾"	12	600
LNA1003	1"	1¾"	12	600
LNA1004	1½"	1¾"	12	600
LNA1005	2"	2"	12	300
LNA1006	2½"	2"	12	240
LNA1007	3"	2½"	12	240
LNA1008	4"	2½"	12	120
LNA1009	5"	2½"	12	120
LNA1010	6"	2¾"	12	120

- For all paint types

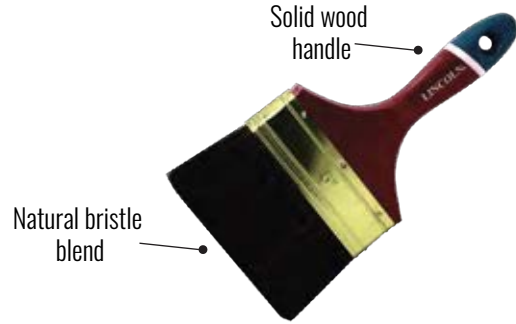

Paint Brush

Item Code	Size	Bristle Length	INN	CTN
LNB2001	1"	1½"	12	600
LNB2002	1½"	1½"	12	600
LNB2003	2"	1¾"	12	240
LNB2004	2½"	1¾"	12	240
LNB2005	3"	2"	12	240
LNB2006	4"	2"	12	120
LNB2007	5"	2½"	12	120
LNB2008	6"	2½"	12	120

- For all paint types

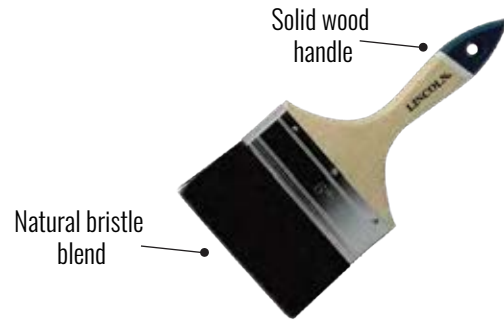

Paint Brush

Item Code	Size	Bristle Length	INN	CTN
LNC3001	1"	1½"	12	600
LNC3002	1½"	1½"	12	600
LNC3003	2"	1¾"	12	240
LNC3004	2½"	1¾"	12	240
LNC3005	3"	2"	12	240
LNC3006	4"	2"	12	120
LNC3007	5"	2½"	12	120
LNC3008	6"	2½"	12	120

- For all paint types



Microfiber Roller Cover

Item Code	Size	Fabric Thickness	PCS	INN	CTN
L9014	4"	3/8"	4	-	100
L9015	4"	3/8"	10	24	96

- Use on smooth surfaces such as plaster, walls, smooth wood and metal surfaces
- Compatible paint type: latex and oil
- Holds up to 3x the paint of standard covers
- PVC core



SMOOTH SURFACES

Microfiber Roller Cover

Item Code	Size	Fabric Thickness	CTN
LNAP001A	9"	3/8"	96

- Use on smooth surfaces such as plaster, walls, smooth wood and metal surfaces
- Compatible paint type: latex and oil
- Holds up to 3x the paint of standard covers
- PVC core

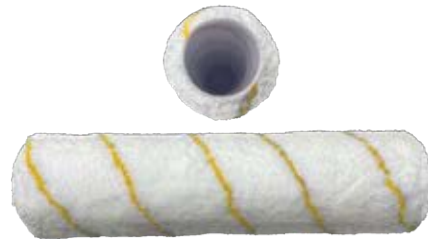

SMOOTH SURFACES

Roller Cover

Item Code	Size	Fabric Thickness	PCS	CTN
LNAP001	9"	3/8"	-	96
LNAP0013	9"	3/8"	3	24

- Use on smooth surfaces such as plaster, walls, smooth wood and metal surfaces
- Made of polyester
- PVC core



SMOOTH SURFACES

Roller Cover

Item Code	Size	Fabric Thickness	CTN
LNAP002	9"	3/4"	96

- Use on paneling, smooth concrete and lightly textured drywall and wood
- Made of polyester
- PVC core



SEMI-SMOOTH SURFACES

Roller Cover

Item Code	Size	Fabric Thickness	CTN
LNAP003	9"	1 1/4"	80

- Use on rough surfaces, such as stucco, textured plaster or ceilings, siding, decks and concrete blocks
- Made of polyester
- PVC core

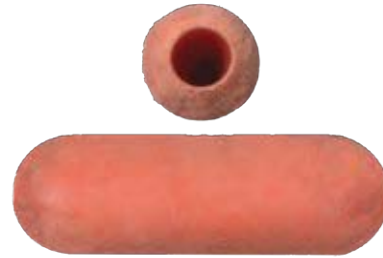

ROUGH SURFACES

Roller Cover

Item Code	Size	Fabric Thickness	CTN
LNAP004	4"	3/8"	80

- Use on smooth surfaces such as plaster, walls, smooth wood and metal surfaces
- Made of polyester
- PVC core



SMOOTH SURFACES

Paint Roller Extension Pole

Item Code	Material	CTN
LPTEP1000	Steel	12

- Professional quality
- Extends from 3 ft to 6 ft
- Metal universal thread tip

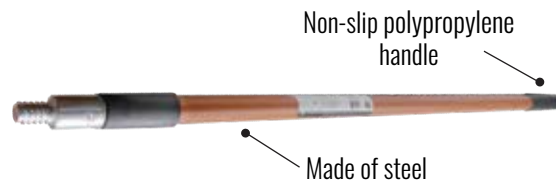

Paint Roller Extension Pole

Item Code	Material	CTN
LPTEP2000	Aluminum	6

- Professional quality
- Extends from 6 ft to 11 ft
- Metal universal thread tip

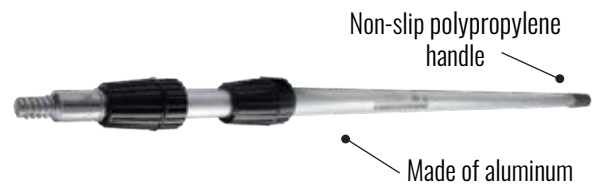

Paint Roller Set

Item Code	Size	PCS	CTN
L9010	4"	10	12



Anti-drip

- Includes:
- 8 pcs - 4" microfiber roller cover
- 1 pc - polypropylene tray
- 1 pc - roller frame



Foam Roller Cover Refill

Item Code	Size	Fabric Thickness	PCS	CTN
L9012	4"	3/8"	3	36

- Compatible with all paint and stains
- PVC core

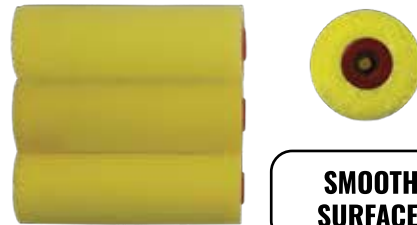

SMOOTH SURFACES

Mini Roller Frame

Item Code	Size	CTN
LPR413	4"	36

- For use with all standard 4" paint roller covers
- Threaded lightweight plastic handle with metal ferrule

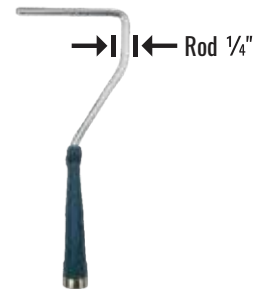

Roller Frame

Item Code	Size	CTN
LPR414	4"	36

- 4-wire cage
- For use with all standard 4" paint roller covers
- Threaded lightweight plastic handle with metal ferrule



Roller Frame

Item Code	Size	CTN
LPR659	9"	24

- 5-wire cage
- For use with all standard 9" paint roller covers
- Threaded lightweight plastic handle with metal ferrule



Heavy Duty Roller Frame

Item Code	Size	CTN
LPR859	9"	24

- 5-wire cage durably crafted with sturdy steel
- For use with all standard 9" paint roller covers
- Professional quality
- Threaded lightweight plastic handle with metal ferrule



Heavy Duty Roller Frame

Item Code	Size	CTN
LPR959	9"	24

- 5-wire cage durably crafted with sturdy steel
- For use with all standard 9" paint roller covers
- Professional quality
- Ergonomic soft grip comfort handle



Paint Roller Set

Item Code	Size	CTN
L9003	9"	12

- Use on smooth surfaces such as plaster, walls, smooth wood and metal surfaces
- Compatible paint type: latex and oil
- Includes:
 - 9" roller cover
 - 9" paint roller frame
 - 9" plastic tray

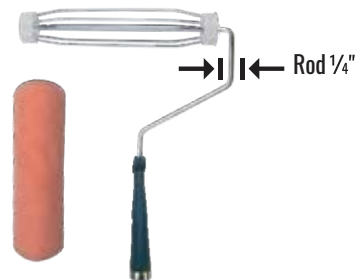

Paint Roller Set

Item Code	Size	CTN
L9005	9"	12

- Use on smooth surfaces such as plaster, walls, smooth wood and metal surfaces
- Compatible paint type: latex and oil
- Includes:
 - 9" roller cover
 - 9" paint roller frame
 - 9" plastic tray

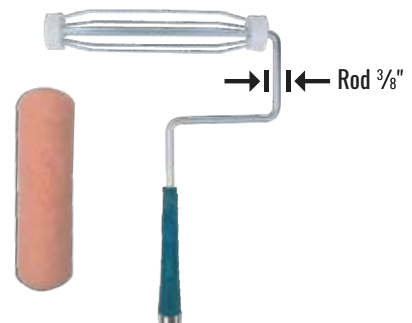

Professional Paint Tools Set

Item Code	PCS	CTN
L9013	8	12

- Use on smooth surfaces such as plaster, walls, smooth wood and metal surfaces
- Compatible paint type: latex and oil
- Includes:
 - 2 pcs - 9" paint roller
 - 2 pcs - 3" paint roller
 - 1 pcs - 9" paint roller frame
 - 1 pcs - 3" paint roller frame
 - 1 pcs - 2" plastic bristle paint brush
 - 1 pcs - polypropylene tray

Anti-drip



Multi-Purpose Paint Kit

Item Code	Size	CTN
L9011	4"	12

- For interior and exterior use
- Suitable for all paint types
- Includes:
 - 4" tray
 - 2" brush
 - 4" roller frame
 - 4" mini foam roller
 - 4" mini fabric roller
 - Applicator with pad



Metal Paint Tray

Item Code	Size	CTN
LPT1000	9"	24

- Holds up to 1 quart of paint or stain



Plastic Paint Tray

Item Code	Size	CTN
LPT0004	4"	48





 **DAKOTA**



Linesman Plier

Item Code	Size	INN	CTN
DACP006	6"	6	60
DACP008	8"	6	60

- 3x more rust-resistant

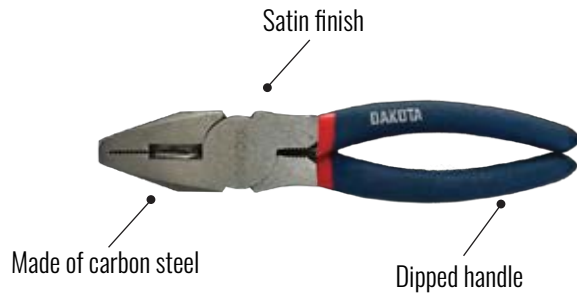

Diagonal Cutting Plier

Item Code	Size	INN	CTN
DADC006	6"	6	60
DADC008	8"	6	60

- 3x more rust-resistant



Long Nose Plier

Item Code	Size	INN	CTN
DALN006	6"	6	60
DALN008	8"	6	60

- 3x more rust-resistant

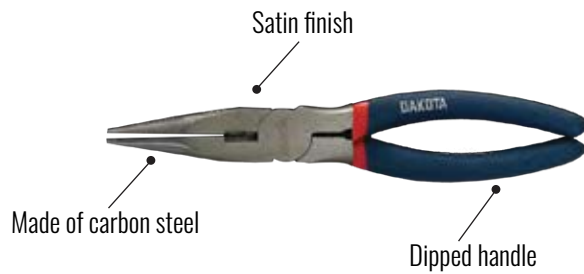

Slip Joint Plier

Item Code	Size	INN	CTN
DASJ006	6"	6	48
DASJ008	8"	6	24

- 3x more rust-resistant



Adjustable Wrench

Item Code	Size	INN	CTN
DAAW006	6"	6	120
DAAW008	8"	6	60
DAAW010	10"	6	60

- 3x more rust-resistant



Pipe Wrench

Item Code	Size	INN	CTN
DAPW0080	8"	6	120
DAPW0010	10"	6	48
DAPW0012	12"	6	36
DAPW0014	14"	6	24

- Heat-treated

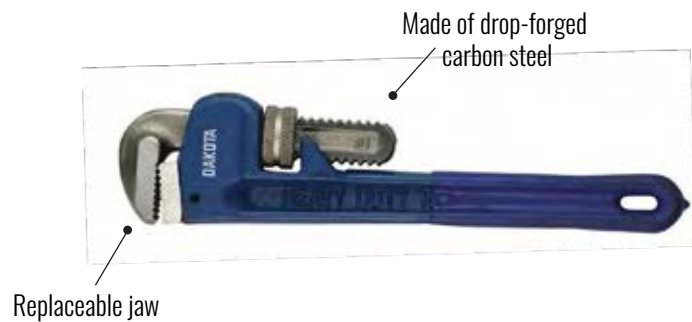

Adjustable Tubular Hacksaw Frame

Item Code	Size	INN	CTN
ATHF09	10"-12"	6	48

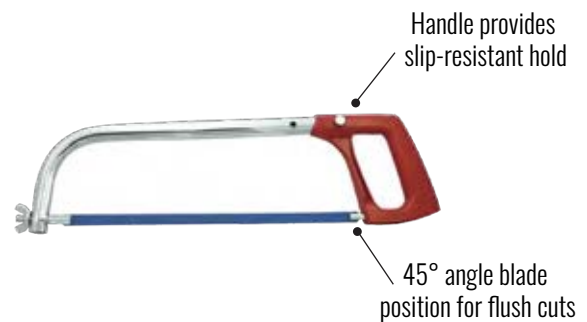

Segmented Diamond Blade

Item Code	Size	Arbor	Max RPM	Diamond Rim	Cutting Method	INN	CTN
DPSG0450	4 1/2"	1/8" - 5/8"	13,300	7 mm	Dry	10	100
DPSG0700	7"	1/8" - 5/8"	8,500	7 mm	Dry	10	40

- For durability and maximum cutting performance
- Lasts longer than abrasive blades
- Use on: construction and masonry materials, block, brick, concrete, paver, and stone

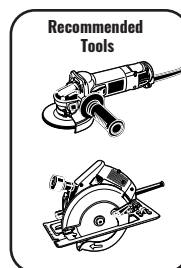

Continuous Diamond Blade

Item Code	Size	Arbor	Max RPM	Diamond Rim	Cutting Method	INN	CTN
DPCR0450	4½"	⅜" - ⅝"	13,300	7 mm	Wet	10	100
DPCR0700	7"	⅜" - ⅝"	8,500	7 mm	Wet	10	40

- For durability and maximum cutting performance
- Lasts longer than abrasive blades
- Use on: ceramic, granite, marble, porcelain, tile, slate, and other natural stones

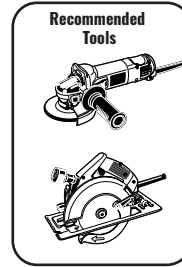

Turbo Diamond Blade

Item Code	Size	Arbor	Max RPM	Diamond Rim	Cutting Method	INN	CTN
DPTR0450	4½"	⅜" - ⅝"	13,300	7 mm	Wet/Dry	10	100
DPTR0700	7"	⅜" - ⅝"	8,500	7 mm	Wet/Dry	10	40

- For durability and maximum cutting performance
- Lasts longer than abrasive blades
- Use on: construction and masonry materials like block, brick, concrete, paver, and stone

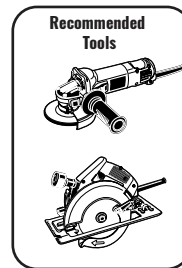

Notch Trowel

Item Code	Size	Square Notch	INN	CTN
DANT1212	11" x 5"	½" x ½"	12	48
DANT1438	11" x 5"	¼" x ⅜"	12	48

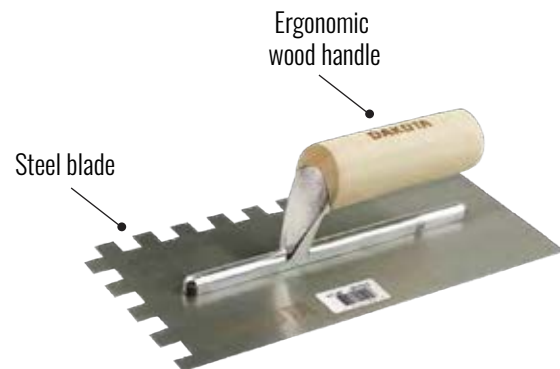

Scraper

Item Code	Size	INN	CTN
BPN002	1 1/2"	12	240
BPN003	2"	12	240
BPN004	3"	12	240
BPN005	4"	12	240
BPN007	6"	12	240



Wire Brush

Item Code	Rows	Description	INN	CTN
WB104	4	Without Scraper	12	120
WB104SC	4	With Scraper	12	120



Entry Door Lock

Item Code	Finish	INN	CTN
DAAB70E	Antique Brass	6	24
DAAC70E	Antique Copper	6	24
DAPB70E	Polished Brass	6	24
DASS70E	Stainless Steel	6	24

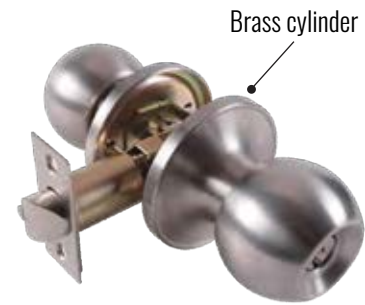

- Meets ANSI grade 3 standards
- Fits all doors 1 1/4" - 2"

Deadbolt Lock

Item Code	Finish	INN	CTN
DAAB01	Antique Brass	6	24
DAAC01	Antique Copper	6	24
DAPB01	Polished Brass	6	24
DASS01	Stainless Steel	6	24



- Meets ANSI grade 3 standards
- Adjustable backset fits both 2 3/8" - 2 3/4"

Double Deadbolt Lock

Item Code	Finish	INN	CTN
DAAB02	Antique Brass	6	24
DAAC02	Antique Copper	6	24
DAPB02	Polished Brass	6	24
DASS02	Stainless Steel	6	24



- Meets ANSI grade 3 standards
- Adjustable backset fits both 2 3/8" - 2 3/4"

Lever Entry Door Lock

Item Code	Finish	INN	CTN
DASS70EL	Stainless Steel	6	24

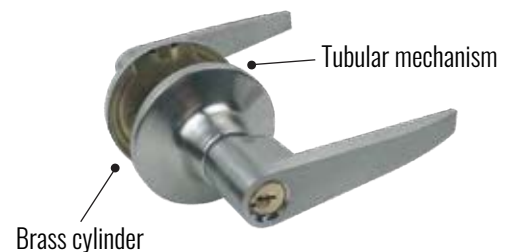

- Meets ANSI grade 3 standards
- Fits all doors 1 1/4" - 2"

Stainless Steel Hinges

Item Code	Size	INN	CTN
DASS025	2.5" x 2.5" x 1.8 mm	5 Pairs	50 Pairs
DASS030	3" x 3" x 2 mm	5 Pairs	50 Pairs
DASS035	3.5" x 3.5" x 2.2 mm	5 Pairs	50 Pairs
DASS040	4" x 4" x 2.5 mm	5 Pairs	50 Pairs



- Ball bearings included
- Provides smooth operation
- For high frequency doors
- Thicker and of much higher quality than residential hinges
- Stainless steel screws included

Steel Butt Hinge

Item Code	Size	INN	CTN
HVIH150	1.5"	12 Pairs	960 Pairs
HVIH200	2"	12 Pairs	600 Pairs
HVIH250	2.5"	12 Pairs	480 Pairs
HVIH300	3"	12 Pairs	240 Pairs
HVIH400	4"	12 Pairs	120 Pairs

- Screws not included



Glove with PVC Dotted Palm

Item Code	INN	CTN
GLOVE001	12	240



PVC dots for extra grip
in dry conditions
(no solvents)

A-Grade Work Glove with Red Cuff

Item Code	Size	INN	CTN
GLOVE002	10.5"	12	72

- For general purpose



Full leather palm,
knuckles, and
finger tips

Leather Work Gloves

Item Code	INN	CTN
GLOVE005	12	120

- Made of cowhide leather
- Knuckle strap provides extra protection

Rubberized safety cuff for wrist protection



Leather Double Palm Work Gloves

Item Code	Size	INN	CTN
GLOVE007	10.5"	12	72

- For construction and heavy duty applications
- Split leather

Double reinforced palm, knuckles, and finger tips



Dust Mask

Item Code	INN	CTN
DADM	50	2000



Plastic Filter Dust Mask

Item Code	INN	CTN
DABDM	30	240

- Lightweight
- For protection against dust



Protective Goggles

Item Code	INN	CTN
GOG	10	100

- Anti-fog vents



Welder's Chipping Hammer

Item Code	Weight	INN	CTN
CHWE5	17 oz (0.5 kg)	6	24

- Use to chip welding or cutting slag off metal

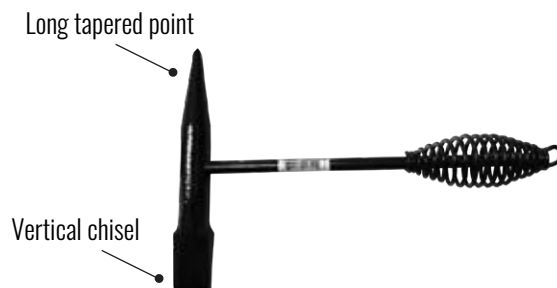

Masonry Chipping Hammer

Item Code	Weight	INN	CTN
CHWE9	17 oz (0.5 kg)	6	36

Drop-forged, heat-treated, hardened head

Well balanced handle



Carpenter Claw Hammer

Item Code	Weight	INN	CTN
CHWE16	16 oz	6	36
CHWE20	20 oz	6	24

- Built for durability and comfort

Made of forged carbon steel

Curved claw for extraction and demolition

Anti-vibration handle

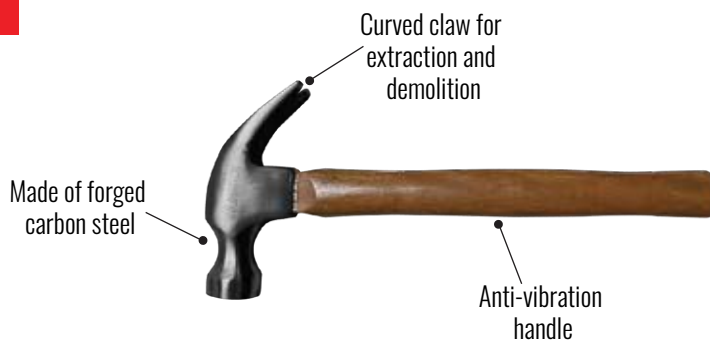

Glass Cutter

Item Code	Description	INN	CTN
3 GLASS	#3	12	240

- For 2-6 mm glass cutting

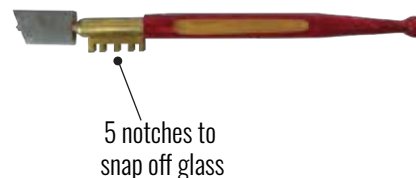

Photoelectric Lighting Control

Item Code	Voltage	Watts	CTN
BRELO054	105-285	1800	100

- Turns light on at dusk and off at dawn
- Locking-type plug configuration



Mercury Bulb

Item Code	INN	CTN
BRELO055	20	40

- 175 W - 39 E



Keyless Lamp Holder

Item Code	Amps	Voltage	Color	INN	CTN
BRELO020	2	250	White	100	1000
BRELO021	2	250	White	50	1000

- For indoor lighting



Porcelain Lamp Holder

Item Code	Color	INN	CTN
BRELO026	White	10	50

- 250 V - 660 W



Lamp Holder Socket

Item Code	Color	INN	CTN
BRELO022	Black	60	240



Pull-Chain Lamp Holder

Item Code	INN	CTN
BRELO041	20	200

- Bakelite material
- 125 V - 600 W



Double Wire Plug

Item Code	INN	CTN
BRELO011	60	240

- 10 A - 250 V



Grounding Adapter

Item Code	Color	INN	CTN
BRELO012	Orange	25	500

- 15 A - 125 V

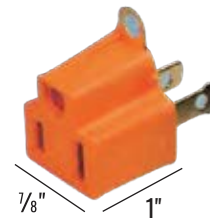

Light Socket Adapter

Item Code	Color	INN	CTN
BRELO023	Ivory	150	600

- 660 W - 125 V

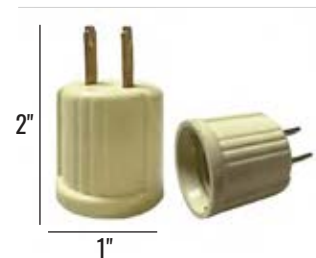

Double Wire Plug

Item Code	INN	CTN
BRELO024	10	200

- 15 A - 250 V

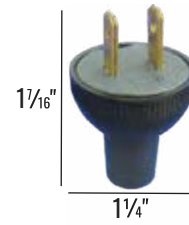

3-Wire Plug

Item Code	INN	CTN
BRELO030	10	200

- 15 A - 125 V
- Made of PVC + ABS
- Copper pins

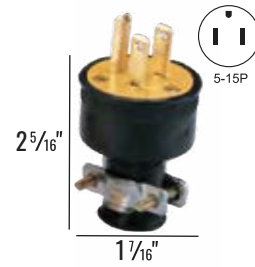

3-Wire Plug

Item Code	INN	CTN
BRELO031	10	200

- 15 A - 250 V
- Made of PVC + ABS
- Copper pins

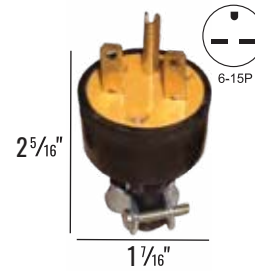

Female Plug

Item Code	INN	CTN
BRELO032	10	200

- 15 A - 125 V
- Made of PVC + ABS
- Copper pins

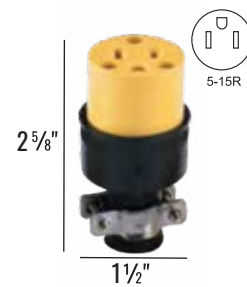

3-Wire Plug

Item Code	INN	CTN
BRELO033	10	200

- 15 A - 125 V
- Copper pins

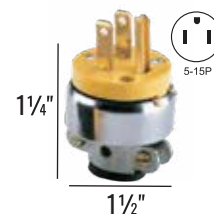

3-Wire Connector

Item Code	INN	CTN
BRELO034	10	200

- 15 A - 125 V

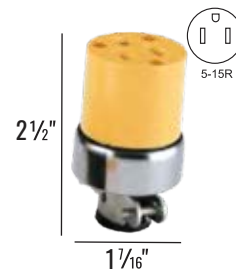

ON/OFF Push Switch

Item Code	INN	CTN
BRELO057	40	160

- 30 A - 500 V



Double Surface-Mount Outlet

Item Code	Color	INN	CTN
BRELO035	Marfil	50	200

- 15 A - 125 V
- Grounding



Double Surface-Mount Outlet

Item Code	Body	INN	CTN
BRELO035-M	Metal	50	100

- 15 A - 125 V
- Metal box body



2-Gang Wall Plate

Item Code	Color	INN	CTN
BRELO037W	White	50	1000

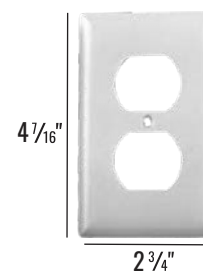

Electrical Metal Wall Box

Item Code	Size	Thickness	INN	CTN
BRELO051	2" x 4"	1.0 mm	50	50
BRELO0518	2" x 4"	0.8 mm	50	50

- Rectangular box



Electrical Metal Wall Box

Item Code	Size	INN	CTN
BRELO052	1/2" x 1/2"	50	50

- Square box



Electrical Metal Wall Box

Item Code	Size	INN	CTN
BRELO059	4" x 4"	50	50

- Square box



Outdoor Extension Cord

Item Code	Length	Color	Gauge	INN	CTN
67361	25'	Orange	16/3	1	24
67362	50'	Orange	16/3	1	12
67363	100'	Orange	16/3	1	6

- 10 Amps
- 125 Volts
- 1259 Watts



Indoor Extension Cord

Item Code	Length	Color	Voltage	INN	CTN
73033	6'	White	110	1	100
73034	9'	White	110	1	100
73035	12'	White	110	1	80
73036	15'	White	110	1	60
73037	20'	White	110	1	50
73038	25'	White	110	1	40



Metal Trouble Work Light with Cord

Item Code	Voltage	Length	INN	CTN
A005	110	25'	20	20

- Metal guard protects bulb from breakage and from accidental contact
- Hook allows for hassle-free hanging



Plastic Trouble Work Light with Cord

Item Code	Voltage	Length	INN	CTN
A006	110	25'	5	20

- Plastic guard protects bulb from breakage and from accidental contact



7 LED Headlamp

Item Code	Voltage	INN	CTN
BR7LED	5	6	60

- AAA battery required
- Ultra bright LED light
- High intensity LED
- Adjustable head strap
- Adjustable inclination



Hanging Scale

Item Code	Capacity	INN	CTN
PSM006	25 kg	6	72
PSM007	50 kg	6	48
PSM012	100 kg	6	24

- Scale shows kgs and lbs
- With hook



PVC Hose Bibb

Item Code	Size	INN	CTN
DAB1234	1/2" x 3/4"	24	240

- Celcon stem



Dual Handle Lavatory Faucet

Item Code	Size	CTN
PKF200	4"	20

Acrylic handles

Non-metallic



Curtain Wire

Item Code	Color	Length	INN	CTN
BRCR	White	100'	1	20



Curtain Screw Eye & Hook

Item Code	Description	INN	CTN
BRCR02	Eye	6	144
BRCR03	Hook	6	144



Curtain Rod Holder

Item Code	Size	Finish	INN	CTN
CRH3400	3/4"	Chrome Plated	12	288



Flat Curtain Rod Holder

Item Code	Size	Finish	INN	CTN
FCRH3400	3/4"	Chrome Plated	12	288



Fishing Line

Item Code	Weight	Length	INN	CTN
BRFL0040	40 lbs	100 m	12	144
BRFL0070	70 lbs	100 m	12	144
BRFL0080	80 lbs	100 m	12	144
BRFL0090	90 lbs	100 m	12	144
BRFL0100	100 lbs	100 m	12	144
BRFL0110	110 lbs	100 m	12	144
BRFL0120	120 lbs	100 m	12	144
BRFL0150	150 lbs	100 m	12	144



Flexible and resistant

- For masonry, handcrafts, fishing, and plumbing

Mosquito Mesh

Item Code	Size	Color	INN	CTN
DAMM5013	3' x 100'	Light Grey	1	6
BRMM5014	4' x 100'	Light Grey	1	6
BRMM6063	3' x 100'	Green	1	6
BRMM6064	4' x 100'	Green	1	6

- Replacement for windows, doors, and patio screens

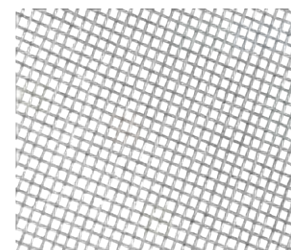

Item Code	Page
102	23
104	23
22500	33
23000	33
23500	33
24000	33
60000	96
60001	96
60002	96
60003	96
60004	96
60005	96
67361	175
67362	175
67363	175
73033	175
73034	175
73035	175
73036	175
73037	175
73038	175
95075	4
95100	4
997075	5
997100	5
997125	5
998100	6
998400	6
0102B	23
10HS10TL80W	7
14HS10SGGPW	7
3 GLASS	170
3000BPSC	46
3002BPSC	46
3003BPSC	46
3004BPSC	46
3006BJSC	46
3008BJSC	46
3009BJSC	46
300AMP	58
3010BJSC	46
45HS10SGGPW	7
45HS10TL80W	7
45HS10TUGPW	8
4HS10SGGPW	7
4HS10TL80W	7
4HS10TUGPW	8
5HS10TUGPW	8
6HS10TUGPW	8
7HS10SGGPW	7
7HS10TL80W	7
7HS10TUGPW	8
7HS10TUGPWT	8
99025BL	5
99275BL	6
99450BL	4
99475BL	4
9HS10TUGPW	8
A005	176
A006	176
AS1003A	141
AS1006A	140
AS2001AA	140
AS401	139
ASPT4003S	141
ATHF02	65
ATHF09	164

Item Code	Page
ATHF20	65
BH4435	31
BM005805	146
BM007000	146
BM007001	147
BM10050L	152
BM10050R	152
BM1351234	115
BM1351234BL	115
BM15050L6	151
BM15050L8	151
BM15050R6	151
BM15050R8	151
BM15156	152
BM2045	150
BM2050	150
BM2070	147
BM2070BL	147
BM2080	147
BM25226	152
BM25228	152
BM3040	148
BM3060	148
BM33196	154
BM33226	154
BM33228	154
BM3511	127
BM4115	133
BM4115T	133
BM4511	127
BM4511T	129
BM550100	119
BM550120	119
BM550125	119
BM550150	119
BM550200	119
BM550340	119
BM880100	118
BM880120	118
BM880125	118
BM880150	118
BM880200	118
BM880300	118
BM880340	118
BM910012	119
BM910034	119
BM910100	119
BM910150	119
BM950012	119
BM950034	119
BM950100	119
BM950150	119
BM950200	119
BM950300	119
BM950400	119
BMA0471	127
BMA0481	131
BMA0490	137
BMA0491	134
BMA0494	135
BMA0494C	138
BMA0494H	138
BMA0494HR	137
BMA2113	129
BMA2401234	115
BMA2401234BL	115
BMA2403434	115

Item Code	Page
BMA2461212	116
BMA3004	133
BMA3010	116
BMA3011B	116
BMA3060	117
BMA3065	117
BMA3101234	115
BMA3251234	115
BMA3351234	116
BMA4044	147
BMA4045	147
BMA4045MN	147
BMA6021	136
BMA6022	136
BMA6023	136
BMA6024	136
BMA7001	137
BMA7004M	135
BMA7010	137
BMAM3401	117
BMBA001	145
BMBA002	145
BMBA003	145
BMBA004	146
BMBA005	146
BMBA006	146
BMBA007	145
BMBA008	145
BMBA009	145
BMBD76	121
BMBSF001CP	133
BMBSF002CP	134
BMBSF003CP	134
BMBV0012	117
BMBV0034	117
BMBV0100	117
BMBW1430	123
BMBW1431	123
BMBW1515	123
BMBW1520	123
BMBW1530	123
BMCB1234	116
BMCB3434	116
BMFD44	122
BMFD66	122
BMFHCO175	120
BMFHCO200	120
BMFL64231	149
BMFL8021	149
BMGV001	117
BMGV002	117
BMGV003	117
BMH002	149
BMH003	149
BMH004	149
BMH007	149
BMH008	149
BMH009	149
BMH221	149
BMH222	149
BMH223	149
BMH224	149
BMH225	149
BMHSS0001	136
BMHSS0002	136
BMHSS005	136
BMHSS7004	135

Item Code	Page
BMHSS7006	135
BMKF001CP	126
BMKF001NM	128
BMKF001SS	125
BMKF002CP	126
BMKF002NM	128
BMKF002SS	125
BMKF003CP	126
BMKF003NM	128
BMKF003SS	125
BMKF004CP	127
BMKF004NM	128
BMKF004SS	125
BMKF005CP	127
BMKF005NM	128
BMKF005SS	125
BMKF006CP	127
BMKF006SS	126
BMLB102000	154
BMLB2118	154
BMLB2223	154
BMLB2325	154
BMLF001CP	130
BMLF001NM	131
BMLF001SS	129
BMLF002CP	130
BMLF002NM	131
BMLF002SS	129
BMLF003CP	130
BMLF003NM	131
BMLF003SS	129
BMLF004CP	130
BMLF004NM	131
BMLF004SS	130
BMLF005NM	132
BMLF006NM	132
BMLF007NM	132
BMNA003	120
BMNA112	120
BMNA114	120
BMNA116	121
BMNA117	121
BMNB1230	138
BMPBW1431	124
BMPBW1515	124
BMPBW1530	124
BMPLO006	132
BMPLO007	132
BMP0114	120
BMPP001	124
BMPP007	124
BMPP008	124
BMPTFE01	127
BMPTFE03	127
BMPTFE04	127
BMPTFE05	127
BMPTW001	121
BMPTW002	121
BMPTW003	121
BMPTW004	121
BMSCV0012	118
BMSCV0034	118
BMSCV0100	118
BMSD0112	122
BMSD0200	122
BMSD0300	122
BMSD0400	122

Item Code	Page
BMSD0500	122
BMSD0600	123
BMSD0700	123
BMSH0015	138
BMSPG001	147
BMSSDP401	138
BMSSDP801	138
BMTBC001	148
BMTPO06	153
BMU0907	153
BMU0907R	153
BMUE208	153
BMUS301	152
BMUS307	153
BMUS401	153
BMUV001	118
BMWF001	155
BMWF002	155
BMWF3001	155
BMWF3002	156
BMWF3003	156
BMWF3004	156
BMWR001	148
BMWR002	148
BPNO02	166
BPNO03	166
BPNO04	166
BPNO05	166
BPNO07	166
BR0040	68
BR006196SN	38
BR008796AB	37
BR008796AC	37
BR008796SN	37
BR0088AB	40
BR0088AC	40
BR0089AB	40
BR0089AC	40
BR0092AB35	40
BR0092AC35	40
BR012996AB	37
BR013096AB	37
BR013096AC	37
BR013996	38
BR014096SN	38
BR014196	38
BR0145AB35	40
BR0146AB	40
BR0146AC	40
BR0155128SNA	38
BR0158128SNA	38
BR0158150SNA	38
BR0158300SNA	38
BR015996AB	37
BR015996AC	37
BR0165	40
BR017096	38
BR017196	38
BR017296SN	38
BR0175AB	37
BR0175AC	37
BR0187128	38
BR018796	38
BR0222AB	41
BR0222AC	41
BR0222SN	41
BR0227	41

Item Code	Page
BR0229	41
BR0230	41
BR0246128SNA	38
BR024696SNA	38
BR025696SN	38
BR104	12
BR106	12
BR108	12
BR110	12
BR112	12
BR11255	87
BR116	12
BR120	12
BR1208	12
BR1208B	12
BR1212	12
BR1212B	12
BR1216	12
BR1216B	12
BR1217	12
BR1217B	12
BR1220	12
BR1220B	12
BR1221	12
BR1221B	12
BR1224	12
BR1224B	12
BR1225	12
BR1225B	12
BR1232	12
BR1232B	12
BR124	12
BR1240	12
BR1240B	12
BR128	12
BR1316	12
BR132	12
BR1320	12
BR1324	12
BR1332	12
BR1340	12
BR1348	12
BR1349	13
BR1349B	13
BR1350	13
BR1350B	13
BR1351	13
BR1351B	13
BR14602	62
BR14603	62
BR14604	62
BR14605	62
BR14606	62
BR14607	62
BR14609	62
BR204	13
BR204B	13
BR206	13
BR206B	13
BR208	13
BR208B	13
BR209	13
BR209B	13
BR210	13
BR210B	13
BR211	13
BR211B	13

Item Code	Page
BR212	13
BR212B	13
BR214	13
BR214B	13
BR216	13
BR216B	13
BR220	13
BR220B	13
BR224	13
BR224B	13
BR232	13
BR232B	13
BR28014	20
BR28016	20
BR28018	20
BR28020	20
BR28022	20
BR28024	20
BR28028	20
BR28032	20
BR28034	20
BR28040	20
BR28048	20
BR28056	20
BR28064	20
BR28100	20
BR28102	20
BR28110	14
BR28112	20
BR28114	14
BR31201	13
BR31202	13
BR31203	13
BR31204	13
BR31205	13
BR31206	13
BR31207	13
BR31208	13
BR31209	13
BR31210	13
BR31211	13
BR31212	13
BR31213	13
BR31214	13
BR401	52
BR403	52
BR404	52
BR405	52
BR406	52
BR4325BP	34
BR4325CP	34
BR4325SN	34
BR50805	59
BR50810	59
BR50833	59
BR56122	14
BR56444	31
BR56445	31
BR56446	31
BR56447	31
BR56448	31
BR56449	31
BR56450	31
BR56451	31
BR56452	31
BR56453	31
BR56454	31

Item Code	Page
BR70ABP	51
BR70ABPT	52
BR70ACP	51
BR70PBP	51
BR70SSP	51
BR70SSPT	52
BR7LED	176
BR805871AB	51
BR805871AC	51
BR805871SS	51
BR8185ABBL	37
BR8185SS	37
BR8185SSBL	37
BR821871AB	51
BR821871AC	51
BR821871SS	51
BRAA0012	83
BRAA0014	81
BRAA0015	81
BRAB01	49
BRAB02	49
BRAB70E	50
BRAB70ET	51
BRAB70PA	49
BRAB71	47
BRAB71T	47
BRAB72	48
BRAB72T	48
BRABCS02	49
BRAC01	49
BRAC02	49
BRAC70E	50
BRAC70ET	51
BRAC71	47
BRAC71T	47
BRAC72	48
BRAC72T	48
BRACP2000	45
BRACP2500	45
BRACP3000	45
BRACP4000	45
BRACP5000	45
BRAG0001	89
BRAG0002	89
BRAG0003	89
BRAG0010	85
BRAG0011	86
BRAG0012	86
BRAG0018	85
BRAG1000	86
BRAG1001	86
BRAG1004	88
BRAG1005	88
BRAG1006	88
BRAG1007	88
BRAG1008	88
BRAG1009	89
BRAG1011	89
BRAG1012	86
BRAG1013	87
BRAG1015	87
BRAG1016	91
BRAG1017	91
BRAG1020	90
BRAG1021	90
BRAG1022	92
BRAG1023	85

Item Code	Page
BRAG1024	85
BRAG2018	91
BRAG2020	91
BRAG2022	91
BRAG2024	91
BRAG2026	91
BRAG2118	91
BRAG2120	91
BRAG2122	91
BRAG2124	91
BRAG2126	91
BRAG5003	87
BRAG5004	86
BRAG5005	88
BRAG5006	88
BRAG5007	85
BRAG5008	87
BRAH16	69
BRAP0060W	2
BRAP0080W	2
BRAP0120W	2
BRAP0180W	2
BRAP0240W	2
BRAP0320W	2
BRAP0400W	2
BRAP1000W	2
BRAP1500W	2
BRAP2500W	2
BRAVS001	60
BRAVS002	60
BRAVS003	60
BRAW006	72
BRAW008	72
BRAW010	72
BRAW012	72
BRB3500BL	21
BRB3502BL	21
BRB45002BL	22
BRB45002HC	22
BRB45010BL	22
BRB45010HC	22
BRB45012BL	22
BRB45012HC	22
BRB45058BL	22
BRB45058HC	22
BRB45060BL	21
BRB45060HC	21
BRB45062BL	21
BRB45062HC	21
BRB45064BL	21
BRB45064HC	21
BRB45182BL	22
BRB45276BL	21
BRBC0014	60
BRBC0018	60
BRBC0024	60
BRBC0036	60
BRBJ00250	44
BRBJ00300	44
BRBJ00400	44
BRBJ00500	44
BRCH001	31
BRCH002	32
BRCH002SC	32
BRCH004	32
BRCH005	32
BRCH006	32

Item Code	Page
BRCH007SC	32
BRCL001	73
BRCL010	58
BRCL020	58
BRCN30100	28
BRCN30150	28
BRCN36200	28
BRCN36250	28
BRCN42300	28
BRCPO06	64
BRCPO08	64
BRCR	177
BRCR02	177
BRCR03	177
BRCT072	105
BRCT074	105
BRCT115	77
BRCW0025	42
BRCW0032	42
BRCW0040	42
BRCW0050	42
BRCW0075	42
BRCW0125	42
BRD060	54
BRD070	54
BRD0702KA	54
BRD0704KA	54
BRD080	54
BRDAH003	33
BRDAH004	33
BRDC001	56
BRDC002	56
BRDC006	63
BRDC008	63
BRDC505BC	56
BRDCK0012	18
BRDCK013	18
BRDCK039	18
BRDF031L	105
BRDF031M	105
BRDF031XL	105
BRDIN10	107
BRDIN11	107
BRDIN13	107
BRDP0080	1
BRDP0120	1
BRDP0220	1
BRDRS1L8114	25
BRDRS1L8114SP	26
BRDRS1L8158	25
BRDRS1L8158SP	26
BRDRS5L8114	25
BRDRS5L8114SP	26
BRDRS5L8158	25
BRDRS5L8158SP	26
BRDWC1L6034	26
BRDWC1L6100	26
BRDWC1L6112	26
BRDWC1L6114	26
BRDWC1L6118	26
BRDWC1L6158	26
BRDWC1L6200	26
BRDWC1L6212	26
BRDWC1L8112	26
BRDWC1L8200	26
BRDWC1L8212	26
BRDWC1L8300	26

Item Code	Page
BRDWC5L6034	26
BRDWC5L6100	26
BRDWC5L6112	26
BRDWC5L6114	26
BRDWC5L6158	26
BRDWC5L6212	26
BRDWC5L8200	26
BRDWC5L8300	26
BRDWC6034B	26
BRDWC6100B	26
BRDWC6112B	26
BRDWC6114B	26
BRDWC6158B	26
BRDWC6212B	26
BRDWC8200B	26
BRDWC8300B	26
BRDWF1L6112	27
BRDWF1L6114	27
BRDWF5L6112	27
BRDWF5L6114	27
BRDWF6112B	27
BRDWF6114B	27
BRDWF6118B	27
BRDWF7716B	27
BREH300	59
BREH500	59
BRELO011	172
BRELO012	172
BRELO020	171
BRELO021	171
BRELO022	171
BRELO023	172
BRELO024	173
BRELO026	171
BRELO030	173
BRELO031	173
BRELO032	173
BRELO033	173
BRELO034	174
BRELO035	174
BRELO035-M	174
BRELO037W	174
BRELO041	172
BRELO051	175
BRELO0518	175
BRELO052	175
BRELO054	171
BRELO055	171
BRELO057	174
BRELO059	175
BREN008	62
BRFB008SS	45
BRFD5001	3
BRFD5002	3
BRFD5003	3
BRFD5004	3
BRFD70120	3
BRFD70400	3
BRFD70600	3
BRFD70800	3
BRFLO040	178
BRFLO070	178
BRFLO080	178
BRFLO090	178
BRFLO100	178
BRFLO110	178
BRFLO120	178

Item Code	Page
BRFL0150	178
BRFPB004	92
BRFPPO01	92
BRGC120	94
BRGC130	94
BRGC140	94
BRGC502	95
BRGC503	95
BRGC504	95
BRGDB0014	14
BRGDB0018	14
BRGDB00316	14
BRGDB0038	14
BRGH001	59
BRGH002	59
BRGH12100	93
BRGH12500	93
BRGH3040W	43
BRGH4060W	43
BRGH5580W	43
BRGH58050	93
BRGH58100	93
BRGHBOOL	43
BRGHD2003	43
BRGHS1003	43
BRGJ010	63
BRGJ012	63
BRGTL0001	93
BRGTL0002	93
BRGTL0003	93
BRGTL0004	93
BRGTL0006	93
BRGTL0007	93
BRGTL0008	93
BRGTL0012	93
BRGTL0013	93
BRGTL3301	93
BRGTL3302	93
BRGTL3303	93
BRGTL3312	93
BRH0025BP	34
BRH0025SN	34
BRH0030BP	34
BRH0030SN	34
BRH0035BP	34
BRH0035SN	34
BRH0035SNBB	34
BRH0040BP	34
BRH0040SN	34
BRHC012	95
BRHC013	95
BRHC014	95
BRHC016	95
BRHC017	95
BRHC018	95
BRHCD0012	19
BRHCD0038	19
BRHD001	44
BRHD002	44
BRHDL0016B	56
BRHEX01	62
BRHEX02	62
BRHF001	66
BRHF006	66
BRHF016	66
BRHGCL0028B	56
BRHGS0005	1

Item Code	Page
BRHGS0010	1
BRHH0004	46
BRHHS12034	27
BRHHS12034B	27
BRHHS12078	27
BRHHS12078B	27
BRHHS12100	28
BRHHS12100B	28
BRHHS12150	28
BRHHS12150B	28
BRHHS12200	28
BRHHS12200B	28
BRHHS12250	28
BRHHS12250B	28
BRHHS12300	28
BRHHS12300B	28
BRHTS12200	28
BRHTS12250	28
BRHTS12300	28
BRHS0300	94
BRHS0400	94
BRHS0500	94
BRHW001	95
BRJSB001	8
BRJSB002	8
BRL0030	55
BRL0040	55
BRL0040KA	55
BRL0050	55
BRL0050KA	55
BRL0060	55
BRL400L	55
BRL400LKA	55
BRL500L	55
BRL500LKA	55
BRL600L	55
BRLEV24FL	79
BRLEV36FL	79
BRLEV48FL	79
BRLEV72FL	79
BRLH005	110
BRLH009	111
BRLLO1	79
BRLN006	64
BRLN008	64
BRLP001	64
BRLP002	64
BRLP003	65
BRLP004	65
BRLWG002	108
BRLWG007	108
BRLWR40	53
BRLWR40L	53
BRLWR50	53
BRLWR50L	53
BRMB001	44
BRMB001EP	44
BRMB002	44
BRMB002EP	44
BRMB013	67
BRMC2002	2
BRMC2003	2
BRMC2007	2
BRMC2008	2
BRMC2011	2
BRMC2013	2
BRMC2015GP	2

Item Code	Page
BRMDS012	36
BRMDS014	36
BRMDS016	36
BRMDS018	36
BRMDS020	36
BRMDS022	36
BRMG1001	3
BRMG1002	3
BRMG1003	3
BRMG1004	3
BRMG1005	3
BRMG1006	3
BRMM5014	178
BRMM6063	178
BRMM6064	178
BRMS1610	99
BRMS1620	99
BRMS1630	99
BRMS1640	99
BRMS1810	99
BRMS1820	99
BRMS1830	99
BRMS1840	99
BRMS1910	99
BRMS1920	99
BRMS2210	99
BRMS2220	99
BRMS2310	99
BRMS2710	99
BRMS3310	98
BRMTC0024	75
BRMTC0024WHL	75
BRMTC0026	75
BRMTC0026WHL	75
BRMTC0029	75
BRMTC0032	75
BRNL3014	73
BRNL3015	73
BRNTR1212	78
BRNTR1234	78
BRNTR1414	78
BRNTR1438	78
BRP0001	104
BRP0002	104
BRP0003	104
BRP0004	104
BRP002B	103
BRP002G	103
BRP003H	102
BRP004T	103
BRPB01	49
BRPB02	49
BRPB70E	50
BRPB71	47
BRPB72	48
BRPH0003	44
BRPH0004	44
BRPH0005	44
BRPH0006	44
BRPH30	46
BRPH40	46
BRPS004	113
BRPT5511	74
BRPT595	74
BRPT7125	74
BRPT814	74
BRPTR02	78

Item Code	Page
BRPTR03	78
BRPTR04	78
BRPTR05	78
BRPTR06	78
BRPTR07	77
BRPTR08	78
BRPTR10	77
BRPTR5	77
BRPTR7	77
BRPTR8	77
BRPTR9	77
BRPVC1	63
BRPW0010	72
BRPW0012	72
BRPW0014	72
BRPW0080	72
BRR201	106
BRR305	106
BRR306	106
BRRB006	1
BRRB0606WD	9
BRRB0614MT	9
BRRB0618MT	9
BRRB0906WD	9
BRRB0914MT	9
BRRB1205NWD	9
BRRB6812GP	9
BRRB9812GP	9
BRRDS001	36
BRRDS002	36
BRRFO01	74
BRRFO02	74
BRRFO03	74
BRRFO04	74
BRRJ000	109
BRRJ001	109
BRRJ002	109
BRRJ003	109
BRRJ004	109
BRRM0016	70
BRRM0024	70
BRRS200	109
BRRS201	109
BRRS202	109
BRRS203	109
BRRS204	109
BRRWB009ST	98
BRRWB010ST	98
BRRWB011ST	98
BRRWB012ST	98
BRRWB080	98
BRRWB090	98
BRRWB100	98
BRRWB110	98
BRRWB120	98
BRRWB130	98
BRRWB140	98
BRS001	82
BRS002	82
BRS003	82
BRS004	82
BRS006	82
BRSB3060	1
BRSB3080	1
BRSB4060	1
BRSB4080	1
BRS002	61

Item Code	Page
BRSC003	61
BRSC004	61
BRSC005	61
BRSC006	61
BRSC008	61
BRSC009	61
BRSC012	61
BRSC013	61
BRSC014	61
BRSC1000	58
BRSC4001	3
BRSC4002	3
BRSCDS1400	36
BRSCDS1600	36
BRSCDS1800	36
BRSCDS2000	36
BRSCDS2200	36
BRSDFO04	68
BRSDFO05	68
BRSDFO06	68
BRSDFO08	68
BRSDP003	68
BRSDP004	68
BRSDP005	68
BRSDP006	68
BRSDP008	68
BRSF01	74
BRSF02	74
BRSF03	74
BRSG9515	94
BRSG9516	94
BRSH002	70
BRSH003	70
BRSH004	70
BRSH012	70
BRSJ006	65
BRSJ008	65
BRSLH030	45
BRSLH040	45
BRSM0036	112
BRSM0048	112
BRSM3600	112
BRSM4800	112
BRSS01	49
BRSS02	49
BRSS3000	33
BRSS3500	33
BRSS4000	33
BRSS70E	50
BRSS70EL	49
BRSS70ET	51
BRSS70PA	50
BRSS70PAL	50
BRSS70PL	52
BRSS71	47
BRSS71L	47
BRSS71T	47
BRSS72	48
BRSS72L	48
BRSS72T	48
BRSS80EL	50
BRSS80PL	51
BRSS81L	47
BRSS82L	48
BRSSCS02	49
BRSTA10C	77
BRSV002GXL	110

Item Code	Page
BRSV002RXL	110
BRSV004GL	110
BRSV004GM	110
BRSV004GXL	110
BRSV004RL	110
BRSV004RM	110
BRSV004RXL	110
BRSV006GL	111
BRSV006GM	111
BRSV006GXL	111
BRSV007RL	111
BRSW312	66
BRSW313	67
BRSW314	67
BRSW318	67
BRSW320	67
BRSW322	67
BRTB100	45
BRTB200	45
BRTB300	45
BRTB400	45
BRTB500	45
BRTB600	45
BRTC0001	29
BRTC0002	29
BRTC0003	29
BRTC0004	29
BRTC0005	29
BRTC0006	29
BRTC0007	29
BRTC0008	29
BRTC0009	29
BRTC0010	29
BRTC0011	29
BRTC0012	29
BRTC0013	29
BRTC0014	29
BRTC0015	29
BRTC10400	9
BRTC10600	9
BRTC12040	10
BRTC12060	10
BRTC12400	9
BRTC12600	9
BRTC14072	11
BRTC18	111
BRTC28	111
BRTC282524	10
BRTC282540	10
BRTC3001	29
BRTC3002	29
BRTC3003	29
BRTC3004	29
BRTC3005	29
BRTC3006	29
BRTC3007	29
BRTC3008	29
BRTC3010	29
BRTC3011	29
BRTC450240	11
BRTC450340	11
BRTC61024	11
BRTC61040	11
BRTC61060	11
BRTC61080	11
BRTC72518	10
BRTC72524	10

Item Code	Page
BRTC72525	10
BRTC72540	10
BRTC93118	12
BRTC93124	12
BRTC93140	12
BRTF008	82
BRTF010	82
BRTF05	92
BRTF08	92
BRTF16	92
BRTF18	92
BRTF19	95
BRTIN010	71
BRTIN012	71
BRTLNO80	62
BRTMC3001	4
BRTMC3002	4
BRTMC3003	4
BRTMC3004	4
BRTMC3005	4
BRTMC3006	4
BRTMC3007	4
BRTMC3008	4
BRTORL9	79
BRTS00014	76
BRTS00018	76
BRTS00116	76
BRTS002	76
BRTS003	76
BRTS00316	76
BRTS004	76
BRTS005	76
BRTS007	78
BRTT08B	76
BRTT08W	76
BRTT09B	76
BRTT09BL	76
BRTT09G	76
BRTT09W	76
BRTT10B	76
BRTT10G	76
BRTT10W	76
BRTTA09C	76
BRTTA09G	76
BRTTA10C	76
BRTTA259C	77
BRTTA259G	77
BRUN005	71
BRUN007	71
BRUN010	71
BRWB005	96
BRWB006	96
BRWB0068	41
BRWB0068G	41
BRWB0810	41
BRWB0810G	41
BRWB09BK	97
BRWB09TB	97
BRWB09YL	97
BRWB1012	41
BRWB1012G	41
BRWB10BK	97
BRWB10TB	97
BRWB10YL	97
BRWB11BK	97
BRWB11TB	97
BRWB11YL	97

Item Code	Page
BRWB1214	41
BRWB1214G	41
BRWB12BK	97
BRWB12TB	97
BRWB12YL	97
BRWB3505	96
BRWP050CW	101
BRWP050CW001	101
BRWP050CW002	101
BRWP050CW004	101
BRWP050CW005	101
BRWP050CW006	101
BRWP050CW007	101
BRWP050CW008	101
BRWP050CW009	101
BRWP075CW	101
BRWP075CW001	101
BRWP075CW002	101
BRWP075CW004	101
BRWP075CW005	101
BRWP075CW006	101
BRWP075CW007	101
BRWP075CW008	101
BRWP075CW009	101
BRWP100JCI	101
BRWP100JCI001	100
BRWP100JCI019	100
BRWP100JSS	102
BRWP100JSS001	100
BRWP100JSS002	100
BRWP100JSS004	100
BRWP100JSS005	100
BRWP100JSS006	100
BRWP100JSS007	100
BRWP100JSS008	100
BRWP100JSS009	100
BRWP100JSS010	100
BRWP100JSS011	100
BRWP100JSS012	100
BRWP100JSS016	100
BRWP100JSS019	100
BRWP100JSS50	102
BRWP100SET	99
BRWP100SET-S	99
BRWP100SET50-S	99
BRWP1300SH	103
BRWP1300SH015	103
BRWP1300SH022	103
BRWP1400SH	103
BRWP1400SH50	106
BRWP500JCI	101
BRWP500JSS	102
BRWP500JSS007	100
BRWP500JSS011	100
BRWP500JSS016	100
BRWP500JSS50	102
BRWP500SET	99
BRWP500SET50	99
BRWP750JCI	101
BRWP750JSS	102
BRWP750JSS007	100
BRWP750JSS011	100
BRWP750JSS016	100
BRWP750JSS50	102
BRWP750SET	99
BRWP750SET-S	99
BRWP750SET50-S	99

Item Code	Page
BRWTC002	30
BRWTC003	30
BRWTC004	30
BRWTC005	30
BRWTC006	30
BRWTC007	30
BRWTC008	30
BRWTC009	30
BRWTC010	30
BRWTC011	30
BRWTC012	30
BRWTC013	30
BRWTC310	30
BRWTC320	30
BRWTC330	30
BRWTC340	30
BRWTC350	30
BRWTC360	30
BRWTC370	30
BRWTC375	30
BRWTC380	30
BRWTC390	30
BRWWB0001SS	5
BRWWB0003SS	5
BRWWB0004SS	5
BRZ00250	44
BRZ00300	44
BRZ00400	44
BS2000A	139
BS3000A	139
BSWE03	70
BSWE04	70
BSWE08	70
BSWE10	70
BSWE12	70
BSWE16	70
BS0000	142
C207A	139
CBT65	112
CBT65430	112
CBT76	112
CBT77	112
CG10	82
CG11	82
CG9	81
CHF10MM	42
CHF12MM	42
CHF14MM	42
CHF9MM	42
CHWE16	170
CHWE20	170
CHWE5	170
CHWE9	170
CP007	58
CRH3400	178
D178A	144
DAAB01	167
DAAB02	167
DAAB70E	167
DAAC01	167
DAAC02	167
DAAC70E	167
DAAW006	164
DAAW008	164
DAAW010	164
DAB1234	177
DABDM	169

Item Code	Page
DACP006	163
DACP008	163
DADC006	163
DADC008	163
DADM	169
DALN006	163
DALN008	163
DAMM5013	178
DANT1212	165
DANT1438	165
DAPB01	167
DAPB02	167
DAPB70E	167
DAPW0010	164
DAPW0012	164
DAPW0014	164
DAPW0080	164
DASJ006	163
DASJ008	163
DASS01	167
DASS02	167
DASS025	168
DASS030	168
DASS035	168
DASS040	168
DASS70E	167
DASS70EL	167
DLA035	142
DM108	105
DPCRO450	165
DPCRO700	165
DPSG0450	164
DPSG0700	164
DPTR0450	165
DPTR0700	165
DS1200	36
DS1400	36
DS1600	36
DS1800	36
DS2000	36
DS2200	36
DT210	57
DT230	57
DT260	57
E268	143
E268W	143
ETS1000	142
ETS601A	140
EW0016	69
FCRH3400	178
FH0016	69
FH0020	69
FWB001	14
FWB0012	14
FWB0014	14
FWB0034	14
FWB0038	14
FWB0058	14
FWB0078	14
FWB0112	14
FWB0114	14
FWB0118	14
FWB0138	14
FWB0516	14
FWB0716	14
FWB0916	14
GBR104	83

Item Code	Page
GBR105	83
GBR106	83
GBR107	83
GBR108	83
GLOVE 001	168
GLOVE 002	168
GLOVE 004	108
GLOVE 005	169
GLOVE 007	169
GLOVE 010	108
GOG	169
GOG21	106
GOG22	106
GOG23	106
GOG24	107
GR1500	90
HC012	95
HC013	95
HC014	95
HDFDB003	46
HDFDB004	46
HDFDB005	46
HSAW003	19
HSAW004	19
HSAW006	19
HTT0810	114
HTT1012	114
HTT1214	114
HTT1418	114
HTT1620	114
HTT1820	114
HTT2024	114
HTT2030	114
HTT2430	114
HTT2436	114
HTT3040	114
HVIH150	168
HVIH200	168
HVIH250	168
HVIH300	168
HVIH400	168
L9003	161
L9005	161
L9010	160
L9011	162
L9012	160
L9013	162
L9014	158
L9015	158
LC01020404	15
LC01020408	15
LC01020608	15
LC01020804	15
LC01020808	15
LC01040804	15
LC01090608	15
LC01141438	15
LC02010804	15
LC02070804	15
LC06020808	16
LC06021208	16
LC08013208	16
LC08051604	16
LC08081604	16
LC08081608	16
LC09021604	16
LC09021608	16

Item Code	Page
LC12041208	17
LC12061204	17
LC12062408	17
LC12072408B	17
LC12081708	17
LC12122408	17
LC16020604M	18
LC17223504	18
LNA1001	157
LNA1002	157
LNA1003	157
LNA1004	157
LNA1005	157
LNA1006	157
LNA1007	157
LNA1008	157
LNA1009	157
LNA1010	157
LNAP001	158
LNAP0013	158
LNAP001A	158
LNAP002	158
LNAP003	159
LNAP004	159
LNB2001	157
LNB2002	157
LNB2003	157
LNB2004	157
LNB2005	157
LNB2006	157
LNB2007	157
LNB2008	157
LNC3001	157
LNC3002	157
LNC3003	157
LNC3004	157
LNC3005	157
LNC3006	157
LNC3007	157
LNC3008	157
LPR413	160
LPR414	160
LPR659	160
LPR859	161
LPR959	161
LPT0004	162
LPT1000	162
LPTEP1000	159
LPTEP2000	159
MT0160	57
MT0260	57
MT11260	57
MT3460	57
NAG31	56
NA9865BK -	53
NA9865BK	53
NA9865L	53
NA9865S	52
NC0407	42
NC0508	42
NC0610	42
NT1013BL	80
NT1036BL	80
NT163BL	80
NT165BL	80
NT16P	80
NT25P	80

Item Code	Page
PET0068	113
PET0810	113
PET1012	113
PET1214	113
PET1216	113
PET1220	113
PET1225	113
PET1416	113
PET1418	113
PET1620	113
PET1820	113
PET1824	113
PET2020	113
PET2024	113
PET2030	113
PET2040	113
PET2430	113
PET2436	113
PET2440	113
PET2555	113
PET3040	113
PET3050	113
PET3460	113
PET4040	113
PET4060	113
PET50100	113
PTH800P	24
PTH800P220	24
PKF200	177
PM001	73
PM002	73
PM003	73
PM004	73
PSM006	176
PSM007	176
PSM012	176
PT004	57
PT008	57
PT260	57
R11000	90
R11022	90
RC4000	35
RC5000	35
RC6000	35
RIV7022	65
ROP3000	104
SAB072	69
SBH0030	33
SBH0035	33
SBH0040	33
SCETS1000	142
SCETS2000	143
SE731SC	93
SG2000	84
SG4000	84
SG5000	84
SH1000	109
SH2000	109
SH3000	109
SH4000	109
SQ0812	79
SQ2416	79
SQC12	80
SSH2500	33
SSH3000	33
SSH3500	33
SSH4000	33

Item Code	Page
SSH4300	33
ST0068S	114
ST0810S	114
ST1012S	114
ST1216S	114
ST1620S	114
ST1820S	114
ST1824S	114
ST2020S	114
ST2030S	114
ST2430S	114
ST3040S	114
ST3050S	114
SURVEY 1	80
SURVEY 2	80
SURVEY 4	80
TRO04	35
TRO05	35
TRO06	35
TRO07	35
TRO08	35
TRO09	35
TRO10	35
TRO11	35
TRO12	35
TS100	141
TTD001	107
TTD002	107
UC207A	142
WB0068	42
WB0810	42
WB1012	42
WB104	166
WB104SC	166
WB1214	42
WBR24	70
WBR30	70
WBR36	70
WH2000	107
WHS0012	18
WHS0038	18
WPS9013	102
WPS9069	102
Z1C-CB11	23
Z1C-CB22	23
Z1C-DY34-220	23
Z1C-DY34-28D	23



DURABLE • RELIABLE • VALUE



